

BAM

IRMM and BAM Information
Reference materials

**Certification of Antimony Implanted in
Silicon Wafer with a Silicon Dioxide Diffusion Barrier**

**IRMM-302
BAM-L001**

LEGAL NOTICE

Neither the European Commission nor the Bundesanstalt für Materialforschung und -prüfung nor any person acting on behalf of either Institution is responsible for the use which might be made of the following information

CONTACT

Bundesanstalt für Materialforschung
und -prüfung (BAM)
Department Analytical Chemistry;
Reference Materials
Unter den Eichen 87, D - 12205 Berlin, Germany
Tel.: +49-30-8104-0 Fax: +49-30-8112029
sales.crm@bam.de
URL:

European Commission, Joint Research Centre
Institute for Reference Materials and
Measurements (IRMM)
Reference Materials Unit
Retieseweg, B - 2440 Geel, Belgium
Tel.: +32-14-571 719 Fax: +32-14-590 406
bcr.sales@irmm.jrc.be
URL: <http://www.irmm.jrc.be>

© European Communities and Bundesanstalt für Materialforschung und -prüfung,
2001

Reproduction is authorised provided the source is acknowledged.

Printed in Belgium

IRMM and BAM information
REFERENCE MATERIALS

**Certification of Antimony Implanted in
Silicon Wafer with a Silicon Dioxide Diffusion Barrier**

IRMM-302
BAM-L001

K.H. Ecker⁽¹⁾, U. Wätjen⁽²⁾, A. Berger⁽¹⁾, R. Grötzschel⁽³⁾,
L. Persson⁽²⁾, W. Pritzkow⁽¹⁾, M. Radtke⁽¹⁾, G. Riebe⁽¹⁾,
H. Riesemeier⁽¹⁾, J. Vogl⁽¹⁾

⁽¹⁾ Bundesanstalt für Materialforschung und -prüfung (BAM)
D-12200 Berlin, Germany

⁽²⁾ European Commission, Joint Research Centre
Institute for Reference Materials and Measurements (IRMM)
B-2440 Geel, Belgium

⁽³⁾ Forschungszentrum Rossendorf (FZR)
D-01314 Dresden, Germany

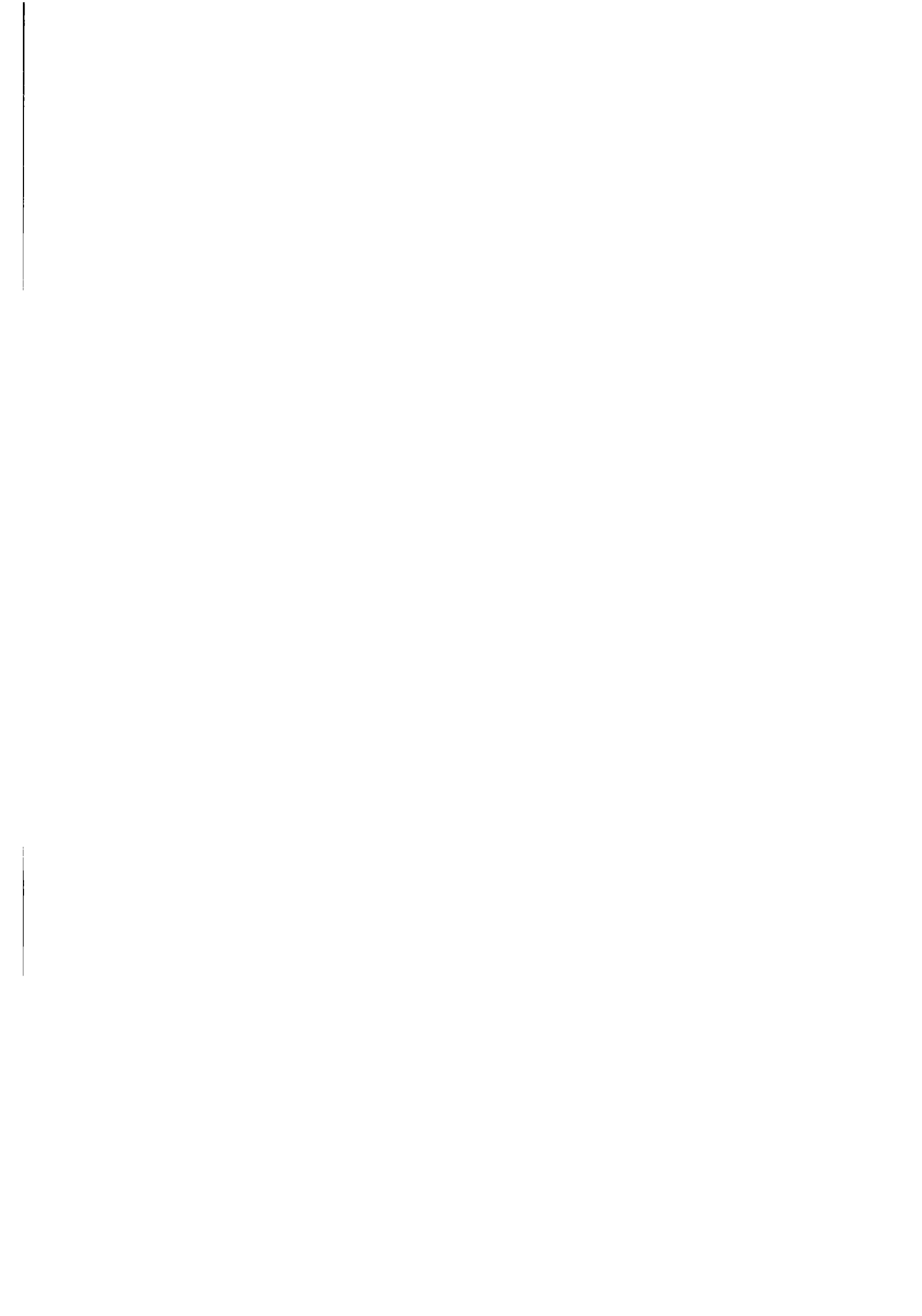

SUMMARY

This report describes the certification of the reference material Antimony implanted in Si/SiO₂ intended to be used for calibration of surface and near surface analytical methods. It describes the preparation, homogeneity measurements and the analytical work performed for the certification of both the areal density of antimony atoms (retained dose) and the isotope amount ratio as well as giving considerations on the stability of the material.

The certified values with their expanded uncertainties $U_{CRM} = k \cdot u_{cert}$ (with a coverage factor $k = 2$, corresponding to a level of confidence of about 95%, and the combined standard uncertainty u_{cert}), are:

areal density of Sb atoms	$(4.81 \pm 0.06) \times 10^{16} \text{ cm}^{-2}$
isotope amount ratio $n(^{121}\text{Sb}) / n(^{123}\text{Sb})$	1.435 ± 0.006

Informative values:

Areal density of the sum of Si, O and Sb atoms in the oxide layer	$(5.9 \pm 0.7) \cdot 10^{17} \text{ cm}^{-2}$
Areal density of the sum of Si, O and Sb atoms in the layer corresponding to the projected range of the Sb distribution	$(9.9 \pm 1.1) \cdot 10^{17} \text{ cm}^{-2}$
Areal density of the sum of Sb and Si atoms in the layer corresponding to the width of the Sb distribution (full width at half maximum)	$(6.5 \pm 0.8) \cdot 10^{17} \text{ cm}^{-2}$

Here the expanded uncertainties (given with $k = 2$) are estimated assuming upper and lower bounds of $\pm 10\%$ to the stopping cross sections used for He ions in Si and SiO₂.

LIST OF ABBREVIATIONS AND SYMBOLS

Throughout the report the following abbreviations are used:

CRM	Certified Reference Material
GUM	Guide to the Expression of Uncertainty in Measurement [1]
ICP-IDMS	Inductively coupled plasma isotope dilution mass spectrometry
ICP-MS	Inductively coupled plasma mass spectrometry
IDMS	Isotope dilution mass spectrometry
INAA	Instrumental neutron activation analysis
IUPAC	International Union of Pure and Applied Chemistry
MS	Mass spectrometry
PIXE	Particle induced X-ray emission spectrometry
RBS	Rutherford backscattering spectrometry
SI	Système International d'Unités, International System of Units
SIMS	Secondary ion mass spectrometry
SNMS	Secondary neutral mass spectrometry
SY-XRF	Synchrotron X-ray fluorescence spectrometry
UHV	ultra-high vacuum
XRF	X-ray fluorescence spectrometry
k	coverage factor according to GUM
n	number of isotopes or atoms
s	standard deviation
u_{index}	combined standard uncertainty according to GUM
U	expanded uncertainty according to GUM

Abbreviations of participating institutes:

BAM	Bundesanstalt für Materialforschung und -prüfung, Berlin, D
FZR	Forschungszentrum Rossendorf, Rossendorf, D
IRMM	Institute for Reference Materials and Measurements, Geel, B

TABLE OF CONTENTS

	Page
1. Introduction	1
2. Participants	2
3. Preparation of the CRM	3
4. Homogeneity	4
5. Stability	8
6. Certification measurements	9
- RBS	9
- INAA	16
- ICP-IDMS	19
- Depth distribution	24
7. Summary of certification results	26
8. Instructions for use	29
9. References	29

1. INTRODUCTION

Techniques to analyze surfaces and near-surface regions like SIMS, SNMS, PIXE and XRF require reference materials for quantitative analysis. RBS is in principle an absolute method which can render analytical results based on fundamental physical parameters. However, accurate calibration of an RBS setup, i.e. the determination of the detector solid angle and the ion charge can be quite difficult. Thus in practice reference samples are also desirable for accurate quantitative RBS measurements. It was the aim of this work to provide a thin layer reference material for these techniques. 400 keV Sb ions were implanted with a nominal dose of $5 \times 10^{16} \text{ cm}^{-2}$ into a high purity silicon wafer with a surface oxide layer to act as a diffusion barrier. Implantation was used because it provides a rugged layer which cannot easily be destroyed. The element Sb was chosen since it is of interest in semiconductor technology, and in addition it is well suited for accurate measurements with RBS, INAA and ICP-IDMS. Traceability of the certified quantity - the areal density (number of atoms per cm^2) - to SI units was achieved in case of RBS measurements by weighing thin metal layers, vapour-deposited in ultra-high vacuum onto the samples as internal standard, and in case of INAA and ICP-IDMS measurements by gravimetrically prepared standard solutions.

2. PARTICIPANTS

Implantation: FZR

Homogeneity: BAM laboratory I.41

Analysis:

RBS : Evaporation of Au layer as internal standard at IRMM

Homogeneity of Au layer at IRMM (RBS)

RBS analysis at IRMM and BAM laboratory I.41

INAA: BAM laboratory I.43

ICP-IDMS: BAM laboratory I.42

3. PREPARATION OF THE CRM

A three inch high purity silicon wafer (orientation <100>) was dry thermally oxidized to form an amorphous SiO₂ surface layer of 100 nm nominal thickness. This wafer was then implanted with 400 keV Sb ions using a 500 keV High Voltage Engineering Corporation (HVEC) ion implanter at FZR. To avoid channeling the normal of the wafer surface was tilted by 7° with respect to the ion beam and the phase of the Si wafer was rotated by 30° out of the horizontal direction. The exit slit of the implanter was opened to allow the isotopes ¹²¹Sb and ¹²³Sb to be implanted with a ratio near the natural isotope amount ratio. The ion beam was swept with an electrostatic scanning system across the Si wafer and 4 Faraday cups located around the wafer. The ion dose was determined by charge collection in the 4 Faraday cups and was nominal 5 x 10¹⁶ Sb-ions per cm². The implanted wafer was then cut with a diamond saw into 32 chips of 10 mm x 10 mm and 20 smaller edge pieces. Individual chips were packaged in plastic boxes at IRMM, retaining the numbering of the chips (see Fig. 1). Chips with numbers in bold letters were sent to BAM, the rest remained at IRMM.

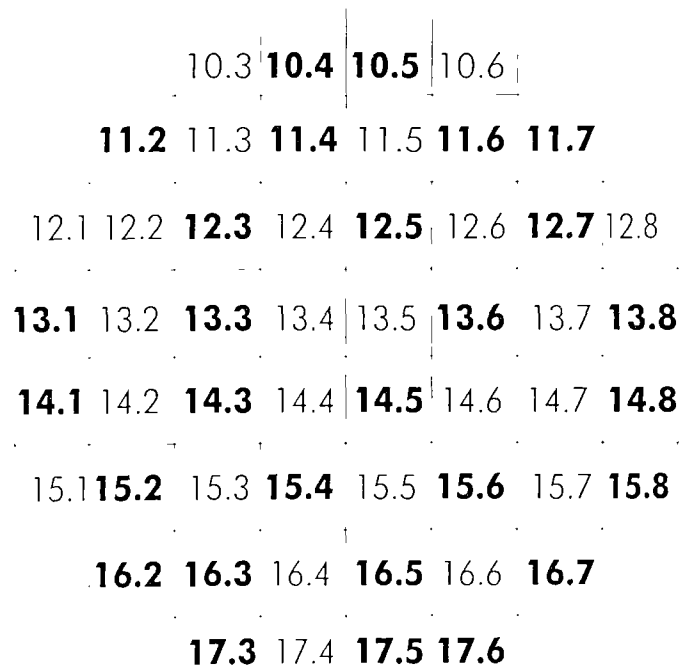

Figure 1: Numbering of the chips.

4. HOMOGENEITY

4.1 RBS measurements

Homogeneity of the areal density of implanted antimony in a single chip and between chips was first measured at BAM with RBS using a 1.5 MeV He ion beam with 1mm beam diameter. Individual RBS measurements on every second chip were performed under constant geometrical conditions. In addition, on two chips three measurements were taken in three spots 3 mm apart in order to check for homogeneity within chips. The integral counts in the Sb peak I_{Sb} divided by the relative integral charge Q of the incoming He ions was determined for each measurement. The relative ion charge was measured with an annular Faraday cup. This is a cup with a central hole allowing the transmission of a part of the beam. The ratio of transmitted charge to the charge collected in the annular cup was calibrated with a second conventional Faraday cup before and after every RBS measurement.

To check the uncertainty of the relative charge measurement repeated measurements were performed on a Rhodium reference sample supplied by IRMM [2]. As with the Sb layer, the integral counts in the Rh peak I_{Rh} divided by the relative integral charge Q was determined at least 5 times per day. The coefficient of variation or relative standard deviation s^{rel} (standard deviation s divided by mean \bar{x} of ratios) of the single measurements I_{Rh}/Q during one day was always less than 0.6%. However, in the period of the homogeneity measurements from 25th of August 1999 until 4th of January 2000 the ratio I_{Rh}/Q varied by up to 3.5%. This is thought to be due to small day-to-day changes in ion energy and changes in the calibration of the annular Faraday cup. Therefore, the ratio $(I_{Sb}/Q)/(\overline{I_{Rh}/Q}) = I_{Sb}/I_{Rh}$ was used to test the homogeneity with $\overline{I_{Rh}/Q}$ being the mean value of I_{Rh}/Q of the day when I_{Sb}/Q was measured. For samples 13.2 and 15.5 which have a thin Au layer vapour-deposited on top (see section 6.1.1) the Sb counting rates have been corrected for the energy loss in the Au layer.

The within-chip measurements gave a relative standard deviation of less than 0.6%. The results of the homogeneity measurements between chips are given in Table 1 and Fig. 2a where the ratios I_{Sb}/I_{Rh} normalized to the mean value are shown. The error bars in Fig. 2a indicate the combined standard uncertainty of an individual ratio measurement I_{Sb}/I_{Rh} . The lines indicate the mean value and the interval $\pm 2s^{rel}$, where $s^{rel} = 0.78\%$ is the relative standard deviation of the ratio measurements of the chips. Except for sample 14.8 all measurements fall within the $2s$ interval.

4.2 SY-XRF measurements

With the INAA and ICP-IDMS measurements the content of ^{121}Sb and ^{123}Sb atoms in the *entire chip* is obtained, and with the measured surface area the *mean areal density* of Sb. Because of this, the small uncertainties (cf. sections 6.2 and 6.3 below) obtained with INAA and ICP-IDMS measurements are not directly valid for the intended use of the reference material with analyzing beams of the order of 1 mm in diameter or smaller. In order to draw full benefit of the high accuracy of the INAA and ICP-IDMS measurements, the uniformity of the lateral distribution of the Sb ions within a chip and between chips needs to be established with comparably small uncertainty, smaller than obtained with RBS.

We have therefore carried out SY-XRF measurements using synchrotron radiation from the recently installed wavelength shifter at the Berlin Electron Synchrotron BESSY II. SY-XRF, although not very accurate for absolute measurements, is an ideal method for fast high precision relative measurements. In the present case the signal from the implanted Sb atoms is measured relative to the signal from the Si Substrate. The high intensity of the synchrotron light source enables fast measurements with small monochromatic beams. An intense monochromatic photon beam of size 0.3 mm x 0.3 mm was obtained with a monochromator system consisting of two silicon (111) crystals. One of the crystals can be bent to focus the beam in horizontal direction. The vertical size of the beam was defined by a slit. A beam energy of 7 keV was chosen to excite the fluorescence radiation in the present samples, a compromise allowing sufficient excitation of the Sb-L fluorescence lines and their good separation from the Rayleigh scatter peak. It should be noted that at this low energy Compton scattering is small. Attempts with higher photon energies (33 keV) to excite the Sb-K lines resulted in larger uncertainties due to reduced beam intensity and larger background due to Compton scattering. A 10 mm² Si(Li) detector with nominal resolution of 130 eV at 5.9 keV photon energy was used. The detector was placed at a distance of 2.5 cm from the samples, perpendicular to the photon beam in the plane of the electron storage ring to take advantage of the polarization of the synchrotron light. This geometry assures minimum background from scattered radiation. A Kapton filter of 25µm thickness was placed in front of the detector to reduce the intensity of the Si-K radiation to the level of the Sb-L radiation. The samples were inclined by 45° with respect to the photon beam and the detector. Thus the analyzed area on the sample is about 0.3 mm x 0.4 mm in size. The relative areal density of Sb was determined from the ratio of Sb-L to Si-K X-rays, with the Si substrate acting as an internal standard. From repeated measurements on the same spot of a sample the relative uncertainty of a single ratio measurement is determined to

be less than 0.4%. Eight measurements 1 mm apart on one chip resulted in a relative standard deviation of 0.37% for measurements within a chip. The measurement results between chips are given in Table 1 and Fig. 2b. We obtain a relative standard deviation of 0.38% with SY-XRF which is smaller by a factor of 2 compared to the RBS measurements. No significant deviation from the mean value was observed across the wafer. No correlation between RBS and SY-XRF with respect to the deviation of the values of individual samples from the mean value could be seen. In particular the deviation from the mean value observed for sample 14.8 with the RBS measurement was not observed with the SY-XRF measurement.

The conventional separation between within-sample homogeneity u_{wb} and between-sample homogeneity u_{bb} is not applicable here, because this material is intended to be used with beam techniques analyzing only a fraction of the chip surface at a time (e.g. 0.3 mm x 0.4 mm). With these SY-XRF measurements, the material homogeneity is characterized for such small fractions (0.3 mm x 0.4 mm). We determine the homogeneity as the standard deviation s of the SY-XRF results and use later (see section 7) the expression $u_{inhom} = s$ as the uncertainty contribution from the material inhomogeneity to the certified value. Thus u_{inhom} covers both conventional terms u_{bb} and u_{wb} [9]. In relative terms $u_{inhom}^{rel} = 0.38\%$, valid for fractions of the chip surface as small as 0.3 mm x 0.4 mm.

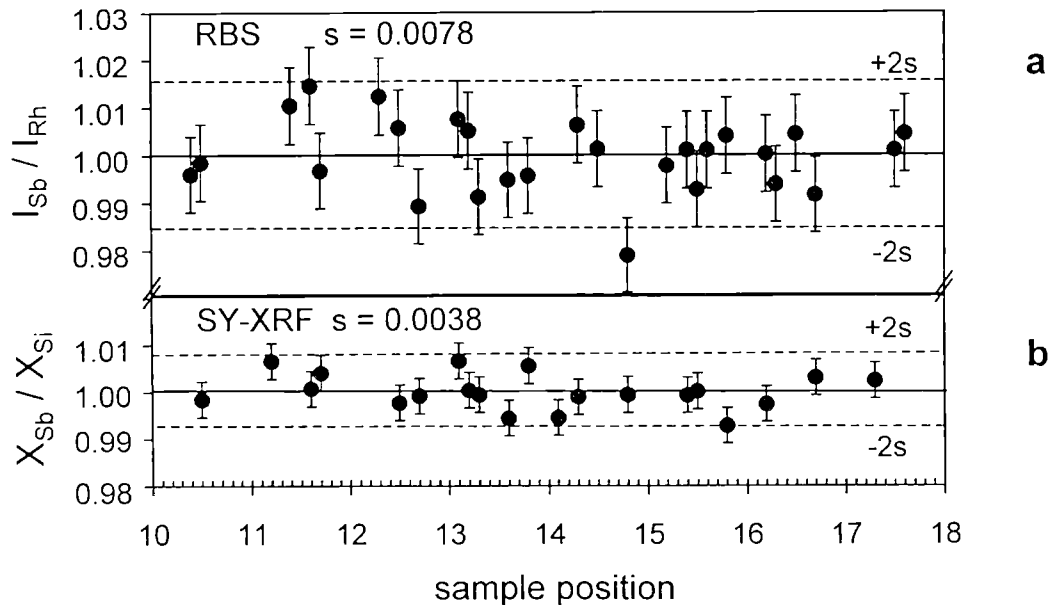

Figure 2: Results of homogeneity measurements for implanted antimony, expressed as ratios of net peak areas normalized to mean values.

Table 1: Homogeneity measurements

sample		RBS	RBS normalized	SY-XRF	SY-XRF normalized
number	position	I_{Sb}/I_{Rh}	$(I_{Sb}/I_{Rh})/(\overline{I_{Sb}/I_{Rh}})$	X_{Sb}/X_{Si}	$(X_{Sb}/X_{Si})/(\overline{X_{Sb}/X_{Si}})$
1	10.4	0.2175	0.9962		
2	10.5	0.2180	0.9986	0.24361	0.99638
3	11.2			0.24560	1.00654
4	11.4	0.2206	1.0106		
5	11.6	0.2215	1.0147	0.24417	1.00068
6	11.7	0.2176	0.9968	0.24499	1.00405
7	12.3	0.2210	1.0125		
8	12.5	0.2196	1.0059	0.24343	0.99768
9	12.7	0.2160	0.9894	0.24378	0.99909
10	13.1	0.2200	1.0076	0.24560	1.00654
11	13.2	0.2194	1.0053	0.24408	1.00035
12	13.3	0.2164	0.9913	0.24385	0.99939
13	13.6	0.2172	0.9949	0.24262	0.99436
14	13.8	0.2174	0.9958	0.24534	1.00551
15	14.1			0.24266	0.99450
16	14.3	0.2197	1.0065	0.24373	0.99889
17	14.5	0.2186	1.0014		
18	14.8	0.2137	0.9790	0.24384	0.99936
19	15.2	0.2178	0.9979		
20	15.4	0.2186	1.0012	0.24383	0.99928
21	15.5	0.2167	0.9929	0.24402	1.00007
22	15.6	0.2186	1.0012		
23	15.8	0.2192	1.0042	0.24224	0.99280
24	16.2	0.2184	1.0003	0.24336	0.99736
25	16.3	0.2170	0.9939		
26	16.5	0.2193	1.0045		
27	16.7	0.2165	0.9917	0.24472	1.00296
28	17.3			0.24456	1.00230
29	17.5	0.2186	1.0012		
30	17.6	0.2193	1.0046		
mean		0.2183	1.0000	0.2440	1.0000
standard deviation		0.0017	0.0078	0.0009	0.0038

5. STABILITY

No detailed stability tests were performed. The SiO₂ layer is intended to act as a diffusion barrier. Sb diffusion in Si is negligible at room temperature [11]. Extrapolating diffusion data for small concentrations of Sb in Si [11] to low temperatures, one can estimate that at 500 °C a change of the width of the distribution by 1% would take about 500 years. The samples were stored at room temperature. Repetition of RBS measurements at BAM during the period from August 1999 to August 2000 revealed no changes of the certified and informative values within the limits of the stated uncertainties. Diffusion data for the case of high concentrations of Sb in the present material are not available. Therefore, to stay on the safe side avoiding possible changes of the Sb implantation profile, it is recommended to keep the reference layers below 150°C.

6. CERTIFICATION MEASUREMENTS

6.1 RBS measurements

6.1.1 Preparation of internal standard

For the accurate and traceable determination of the areal density of the Sb implant with Rutherford backscattering spectrometry (RBS), chips number 13.2, 13.5 and 15.5 were vapour-deposited with a Au layer. This layer was used as an internal standard for these three chips and as external standard for the remaining chips. The Au layers were produced at IRMM by vapour deposition in a UHV apparatus containing a microbalance which allows the in-situ mass determination of the reference layer after vapour deposition by weighing without breaking the vacuum [2,3]. The substitution principle is applied, using a calibrated weight, thus providing for an optimal traceability to the SI unit of mass. The surface area of the Au deposit on the balance pan, which serves as support for the chips, is well-defined to 0.2 % (relative standard uncertainty) with a machine-turned evaporation mask.

For evaporation, the necessary power was supplied through electron bombardment. The base pressure of the UHV system reaches 2×10^{-7} Pa after baking at 250°C, during evaporation the vacuum pressure rose to 5×10^{-5} Pa. The substrates were mounted on a support plate, rotating in the plume of metal vapour, at a distance of ~60 cm from the evaporation source.

Important to note is the difference in area of the weighed Au deposit (56 mm Ø) and of the internal standard effectively used in RBS (1 mm Ø). Therefore, the homogeneity of the Au

Table 2: Thickness (areal density) of deposited Au layers (* on implanted chips)

Chip	Au ratio to mean of weighing	areal density of Au ($\mu\text{g}/\text{cm}^2$)
4.7	0.9773	22.37
6.2	0.9818	22.47
13.5*	1.0010	22.91
2.5	0.9823	22.49
4.1	0.9836	22.51
15.5*	0.9981	22.85
6.5	0.9801	22.43
2.2	0.9766	22.35
13.2*	0.9747	22.31
4.4	1.0009	22.91

deposit at this scale is critical to the application as internal standard. This within-deposit homogeneity was measured at IRMM with an RBS setup described in detail in references [2,3]. The setup employed a rotating target wheel which continuously moved up to 20 samples through the ion beam, thus generating a (circular) line scan of each chip. The ion current was not measured but fluctuations are cancelled out when accumulating over a large number (>2000) of revolutions. The 10 samples measured in the present investigation consisted of three chips from the balance pan (one of them non-implanted) plus additional chips located next to them on the support ring during evaporation (see Fig. 3). Beyond

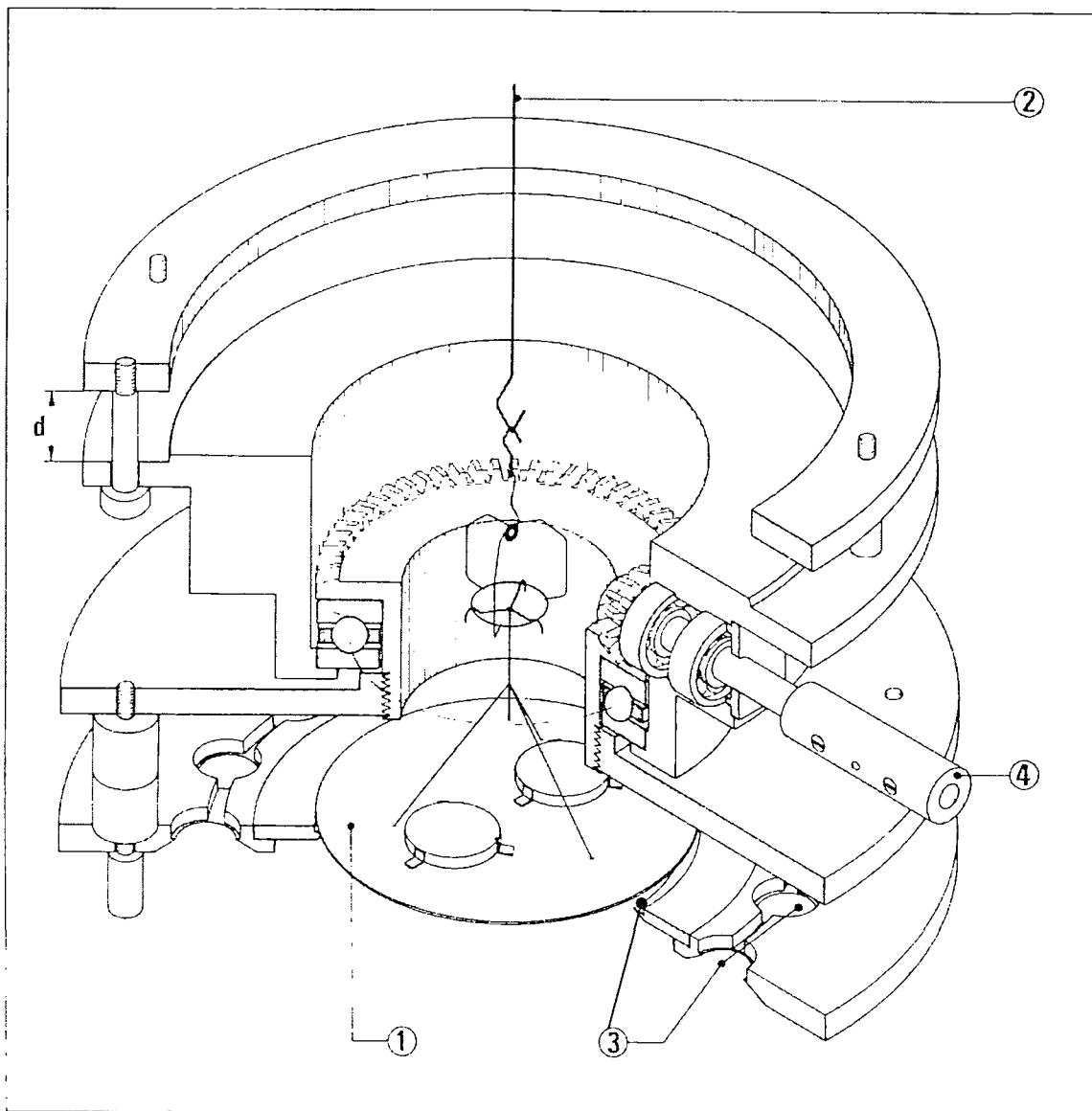

Figure 3: Substrate support and rotating mechanism in the UHV evaporation system with in-situ weighing. (1) balance pan with 2 samples mounted over holes in the pan, (2) suspension from the UHV microbalance, (3) evaporation mask for balance pan and support ring for additional samples, (4) shaft for rotation.

establishing the (within-deposit) homogeneity, individual values for the areal density of Au were assigned, for all chips from balance pan and support ring (Table 2), based on the mean of the weighed chips 13.5, 15.5 and 4.4. Due to geometric considerations, the deposited layer at locations on the support ring must be thinner than on the balance pan. The local thickness variation of Au on a chip (within-deposit homogeneity) was found to be 0.65 % (1 σ).

6.1.2 RBS analysis

On the three Au evaporated chips the backscatter signal of the Au reference layer was measured simultaneously with the signal of the implanted Sb atoms. By calculating the ratio of the two contributions to the RBS spectrum the properties of the detection system and the accumulated He ion charge are canceled out. The only quantity used in the evaluation is the ratio of differential RBS cross sections of Sb and of the reference Au metal which is known from basic physics with an accuracy of better than 1 % (with small corrections for ion

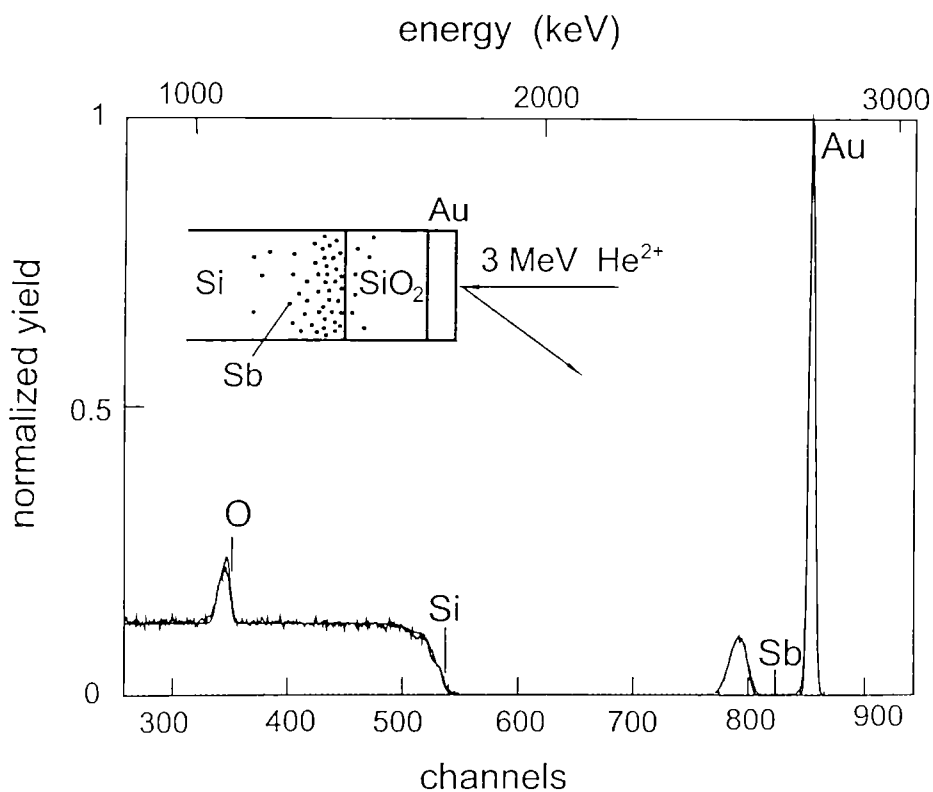

Figure 4: RBS spectrum of implanted Sb in Si with evaporated Au layer.

energy loss and electron screening).

Figure 4 shows a backscatter spectrum of chip number 13.2, an antimony implanted chip with a gold layer of $22.3 \mu\text{g}/\text{cm}^2$ thickness as internal standard.

The spectrum was collected with ${}^4\text{He}^{++}$ ions of 3 MeV energy at a scattering angle of 150° . The high energy was chosen to provide a good separation of the Sb and Au peaks and also to reduce the electron screening correction. Using the thin film approximation, the areal density $(\text{Nt})_{\text{Sb}}$ of the implanted Sb was calculated with the formula

$$(\text{Nt})_{\text{Sb}} = \frac{A_{\text{Sb}}}{A_{\text{Au}}} \frac{\sigma_{\text{Au}}(E)}{\sigma_{\text{Sb}}(E')} F_{\text{sc}} (\text{Nt})_{\text{Au}} \quad (1)$$

where A_{Sb} and A_{Au} are the net peak areas of Sb and Au in the spectrum. σ_{Au} and σ_{Sb} are the scattering cross-sections for the He ions at the appropriate energies E and E' at the position of the thin layers. The energy losses to determine E and E' were calculated using the code SRIM version 2000 [4]. $(\text{Nt})_{\text{Au}}$ is the areal density of the reference Au layer and F_{sc} is the ratio of the correction factors for electron screening [5] for Sb and Au.

All three chips with internal Au standard were analyzed at IRMM. Subsequently chips 13.2 and 15.5 were analyzed at BAM. The experimental conditions of RBS are given in Table 3.

Table 3: RBS experimental conditions

	IRMM	BAM
ion energy	2 MeV	3 MeV
scattering angle	165°	150°
screening correction F_{sc}	0.9919	0.9955

The results of the areal density measurements of Sb with RBS on the three chips with internal Au standard are shown in Fig. 5 and Table 4. The error bars in Fig. 5 and the numbers in brackets in Table 4 indicate the combined standard uncertainty $u_{c,\text{chip}}$ for the measurement result of a chip. The lines in Fig. 5 indicate the mean value of all five RBS results and the interval $\pm 2 s$.

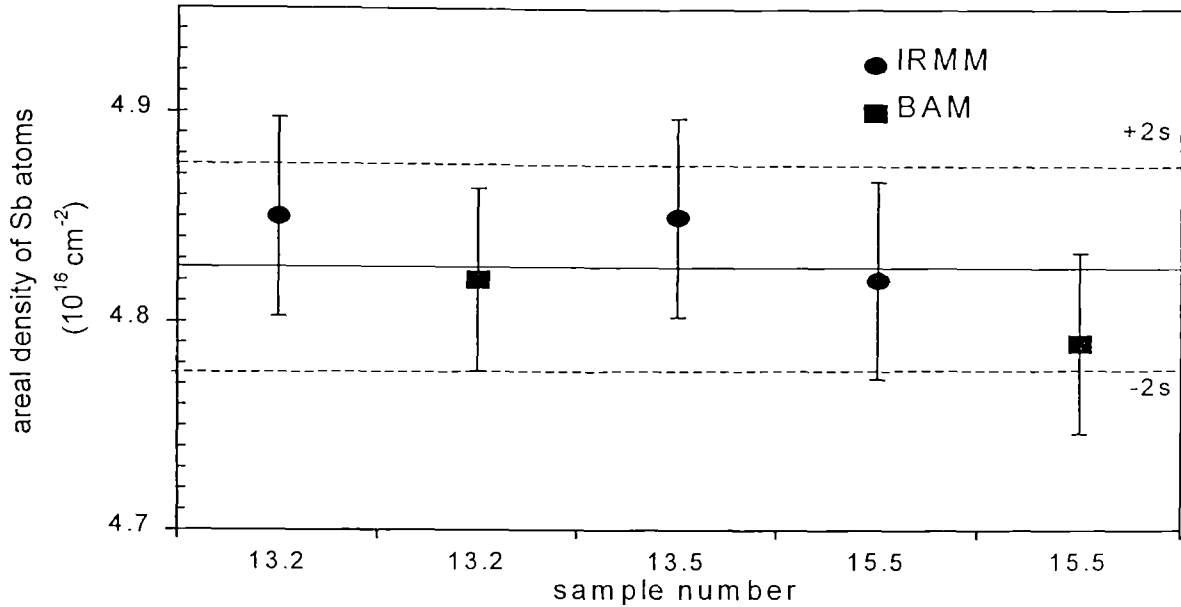

Figure 5: Results of areal density measurements with RBS.

Table 4: Results of areal density measurements with RBS

Chip number	areal density of Au ($\mu\text{g}/\text{cm}^2$)	areal density of Sb atoms (10^{16} cm^{-2})	
		IRMM	BAM
13.2	22.31 (0.12)	4.85 (0.05)	4.82 (0.04)
13.5	22.91 (0.13)	4.85 (0.05)	-
15.5	22.85 (0.13)	4.82 (0.05)	4.79 (0.04)
Mean values and u_c		4.840 (0.046)	4.805 (0.042)
RBS mean value and std. dev. s (n=5)		4.826 (0.025)	

The estimated sources of uncertainties for the determination of $(Nt)_{\text{Sb}}$ in the laboratories of IRMM and BAM are given in Tables 5a and 5b, respectively. The type indication refers to the evaluation method (Type A or Type B) used to obtain the corresponding standard uncertainty component (cf. GUM [1]). The main uncertainty contributions, i.e. the counting statistics and the local Au thickness variations within the deposit, have been reduced by taking three measurements on each chip with a 1 mm beam diameter in three spots 3 mm apart. The contribution of the counting statistics is further decreased by the measurement of 3 and 2 chips, respectively.

Good agreement is found between the RBS measurements of the two laboratories. Since they depend on the same internal standard produced and characterized at IRMM and on the silicon dioxide thickness measurements of BAM, part of the uncertainty contributions to each laboratory's result are identical. These common uncertainty components in the present RBS experiments sum up quadratically to 0.92% for a single measurement and 0.75% for the result of each chip and the laboratory mean value. The exclusively measurement dependent uncertainties (counting statistics and procedure of peak area determination) sum up to 0.57% and 0.46% in the case of IRMM and BAM, respectively. These common and independent components will have to be treated separately when estimating the combined standard uncertainty of the certified value (see section 7).

Table 5a: Relative uncertainty contributions to the accuracy of the IRMM determination of the areal density of the implanted Sb with RBS

Type	(number of replicate measurements)	n=1	n=3	n=9
A	Sb counting statistics	0.5%	0.29%	0.17%
B	Sb net peak area determination including background subtraction	0.5%		
A	Au counting statistics	0.28%	0.16%	0.09%
B	Au net peak area determination including background subtraction	0.2%		
B	Influence from thin layer approximation and from inaccurate E and E' due to SiO ₂ layer thickness, inaccuracy of stopping powers (<10%)	0.5%		
B	Inaccuracy in screening correction	0.1%		
	Contributions from the inaccuracy of the internal standard (total 0.55% at the level of a chip result)			
A	Weighing of Au layer	0.35%		
B	Surface area	0.20%		
A	Local Au thickness variations within the chip	0.65%	0.38%	
Relative combined standard uncertainty $u_{c, ind}$ for a single measurement		1.21%		
Relative combined standard uncertainty $u_{c, chip}$ for a chip result			0.98%	
Relative combined standard uncertainty u_c for the mean IRMM result				0.95%

Table 5b: Relative uncertainty contributions to the accuracy of the BAM determination of the areal density of the implanted Sb with RBS

Type	(number of replicate measurements)	n=1	n=3	n=6
A	Sb counting statistics	0.5%	0.29%	0.20%
B	Sb net peak area determination including background subtraction	0.4%		
A	Au counting statistics	0.25%	0.14%	0.10%
B	Au net peak area determination including background subtraction	0.05%		
B and A	Common contributions from the thin layer approximation, inaccuracy in E and E', stopping powers, screening correction and the internal standard (see Tab. 5a)	0.92%	0.75%	
Relative combined standard uncertainty $u_{c, ind}$ for a single measurement		1.15%		
Relative combined standard uncertainty $u_{c, chip}$ for a chip result			0.91%	
Relative combined standard uncertainty u_c for the mean BAM result				0.88%

For comparison, some of the spectra were analyzed with the computer code GISA [6] which simulates the distribution of the Sb and Au. The results differed by less than 1% from the thin film approximation results obtained with equation (1).

6.2 INAA measurements

The chips number 16.3 and 15.6 were used to determine the areal density of the implanted Sb and the isotope amount ratio $n(^{121}\text{Sb})/n(^{123}\text{Sb})$ with instrumental neutron activation analysis (INAA) [7]. For the preparation of external standards for INAA a dilute solution was prepared gravimetrically by dissolving Sb (Alfa, nominal purity 99,999%) in HNO_3 and HF and diluting with high purity water to 2.012 mg/g. Aliquots of about 20 mg of the solution were brought with a pipette onto 1 cm² squares of thick Whatman filter paper and dried in air. For each sample 7 standards were produced. In order to minimise fluence variations due to the neutron flux gradient in the reactor, the sample and standards were stacked in a quartz ampoule and quartz wool was used to press sample and standards tightly together inside the quartz ampoule. In addition the ampoule was turned periodically during irradiation. The sealed ampoules were irradiated in the “Drehbare Bestrahlungs-Vorrichtung im Reflektor” (DBVR) irradiation device (10^{13} neutrons/cm²/sec) at the BERII reactor at the Hahn-Meitner-Institute (HMI) Berlin. The irradiation times were 5h for sample 16.3 and 4.5h for sample 15.6. After about 24 hours cooling time the samples and standards were unpacked from the quartz ampoule. Due to the neutron capture reaction during the irradiation, radioactive isotopes ^{122}Sb with a half life of $T_{1/2}=2.72\text{d}$ and ^{124}Sb with $T_{1/2}=60.20\text{d}$ are produced which emit specific γ -rays. Samples and standards were measured sequentially for their specific γ -ray counting rate with high purity Germanium detectors in several measuring cycles at HMI and BAM. The distance between sample and detector cap was between 10 cm and 16 cm and was kept constant in each cycle. In contrast to conventional INAA the concentration or the number of atoms of Sb has been calculated separately for the two Sb isotopes in the samples. For the standard solution, values for isotopic abundance and atomic masses have been taken from IUPAC [12] to calculate standard constants.

Results of these measurements are summarised in Table 6. The agreement between the two samples is remarkably good. The isotope amount ratio is slightly different from the natural ratio of $n(^{121}\text{Sb})/n(^{123}\text{Sb}) = 1.3370$.

The estimated sources of uncertainty for the determination of the areal density of Sb and for the ratio $n(^{121}\text{Sb})/n(^{123}\text{Sb})$ by INAA are given in Tables 7 and 8. The largest single contribution to the overall uncertainty of the areal density would have been the preparation of the filter standards, but this was reduced to 0.21% by using 7 standards with each sample. The periodic rotation of the samples during the irradiation could not totally

compensate the neutron flux gradient thus making this uncertainty estimated to 0.5% the largest contribution to the uncertainty.

Table 6: INAA measurement results

Chip number	Sb atoms (10^{16} cm^{-2})	$n(^{121}\text{Sb})/n(^{123}\text{Sb})$
15.6	4.805 (0.029)	1.437 (0.004)
16.3	4.803 (0.029)	1.433 (0.004)

Table 7: Uncertainty budget for areal density determination with INAA

Type		
A	Counting statistics of samples and standards	0.18%
B	Sample area	0.10%
	Uncertainty due to filter standard preparation (total 0.21%)	
B	Concentration of standard solution	0.15%
B	Aliquot amount of standard solution on filter 0.4%, used 7 standards	0.15%
B	Irradiation geometry (neutron flux gradient)	0.50%
B	Counting geometry (distance of detector 10 to 16 cm)	0.10%
B	γ -ray self absorption	0.05%
B	Pulse pileup rejection	0.10%
B	Peak integration including background subtraction	0.10%
	Relative combined standard uncertainty u_c	0.61%

Table 8: Uncertainty budget for $n(^{121}\text{Sb})/n(^{123}\text{Sb})$ determination with INAA

Type		
A	Counting statistics of samples and standards	0.18%
B	Pulse pileup rejection	0.10%
B	Peak integration including background subtraction	0.10%
B	Uncertainty due to IUPAC value of $n(^{121}\text{Sb})/n(^{123}\text{Sb})$	0.15%
	Relative combined standard uncertainty u_c	0.27%

6.2.1 k_0 -NAA measurements

In addition, a measurement with k_0 -NAA of chip number 14.5 was performed by IRMM at channel Y4 of the BR1 reactor of the Studiecentrum voor Kernenergie-Centre d'Etudes Nucléaires (SCK-CEN) in Mol, Belgium. As a special variant of INAA, k_0 -NAA employs only two standards (an Al-Au alloy and a Zr monitor) for the determination of the neutron flux without specific external standards for the determined elements. It requires a very well-known neutron spectrum with constant thermal to epithermal neutron flux ratio, as is the case for BR1 in Mol.

The result of one measurement was $(4.58 \pm 0.46) \times 10^{16}$ Sb atoms/cm², which – within its range of uncertainty – is in accordance with the results of the other methods. However, since the estimated uncertainty is much larger than that of the other employed techniques, this result is not taken into consideration in determining the certified value.

6.3 ICP-IDMS measurements

Two months after the INAA measurements the same chips 16.3 and 15.6 were used to determine the areal density of the implanted Sb with ICP-IDMS. Chips 10.4 and 17.6 were used to determine the isotope amount ratio $n(^{121}\text{Sb})/n(^{123}\text{Sb})$ with ICP-MS. For the measurements a multi-collector mass spectrometer with a hexapole collision cell (IsoProbe, Micromass) was used.

6.3.1 Materials and chemicals

Trace analysis in solid materials with amount contents in the lower mg/kg level requires clean working conditions and specialized sample handling equipment in order to keep the blank contribution and contamination risks small. In this project mainly precleaned perfluoralkoxy (PFA) and quartz ware were used, only the autosampler vials and pipette tips consisted of polypropylene (PP). The applied cleaning procedure is described in detail in the literature [8]. Also the purity of the water and nitric acid used in this project are described in reference [8]. Hydrofluoric acid (HF) was purchased from Merck in ultrapure grade. Sb metal, enriched in ^{121}Sb (99.58) (Chemotrade, Düsseldorf, Germany) was dissolved in a mixture of HNO_3 and HF to prepare the ^{121}Sb enriched spike solution. The accurate amount content of the ^{121}Sb spike solution was characterized using a back spike (primary assay standard) solution gravimetrically prepared from Sb metal (nominal purity 99.999%) showing natural isotopic composition. Both spike and back spike were stored in 4% HF and 10% HNO_3 .

6.3.2 Sample preparation

Following common IDMS procedures the chips (100 mg) were weighed each into a separate PFA-vial of 5 mL volume. To each vial 0.4 g of ^{121}Sb -spike solution with an amount content of 16.5 mg/kg of ^{121}Sb were added gravimetrically. Thereafter the content of the vial, chip and spike solution, was cautiously decomposed using a mixture of 1.2 mL 40% HF and 2.9 mL of 65% HNO_3 . During this process the vial was cooled with tap water. After one hour reaction time the chip was completely dissolved and a clear solution was obtained. The matrix separation was accomplished by volatilizing the silicon in form of silicon tetrafluoride. For this purpose the sample solution was evaporated to dryness at 60°C. The residue was dissolved in 1 mL of a solution containing 4% HF and 10% HNO_3 and subsequently diluted for ICP-MS measurement by using 2% HNO_3 . Spiked blanks and

unspiked samples were prepared in the same way. For blank reduction purposes all preparations were carried out within a clean bench.

Although a complete recovery is not mandatory in IDMS, the rate of the recovery was investigated by ICP-MS measurements to give a detailed description of the whole procedure. This study was carried out by using a silicon chip purchased from the semiconductor industry. The absence of Sb in this material was proven by additional ICP-MS measurements. The surface of the high purity silicon chip was cleaned with a mixture of 75% acetic acid, 25% HNO₃ and 1.5% HF. Thereafter this sample (about 800 mg) was decomposed with a mixture (20 mL) of 40% HF and 65% HNO₃ (mixing ratio 1:2) in the same way as described above. The resulting solution was used as a stock solution for the Si matrix. A blank was prepared in the same way, but without Si. Three subsamples (1 mL) of the matrix stock solution were spiked with 5.3 µg natural antimony and evaporated to dryness at 60°C. The solid residues were dissolved again as described above and filled up to 10 mL for ICP-MS measurements. Three calibration standards were prepared from three subsamples (1 mL) of the matrix stock solution. These subsamples were evaporated to dryness and were spiked with 3.2 µg, 5.3 µg and 8.5 µg antimony, respectively, after completion of the evaporation. The calibration solutions were filled up to 10 mL with the HF/HNO₃ mixture as mentioned above. Cd was added as internal standard to the samples as well as to the calibration solutions. The relative combined standard uncertainty was assessed to be 5 % taking measurement, calibration and spiking process into account. For the calculation of the amount content the ion intensities of both isotopes, ¹²¹Sb and ¹²³Sb, were used separately. A total Sb recovery of (100.6 ± 5.0) % was found for this procedure. The same result was observed for a twofold evaporation to dryness. Thus Sb can be analyzed even in combination with HF, if the temperature of the evaporation steps is kept below 60°C.

6.3.3 ICP-IDMS measurement procedure

All measurements were carried out using a magnetic sector ICP-MS (IsoProbe, Micromass) equipped with a multi-collector system of nine Faraday cups. This ICP-MS system uses a hexapole collision cell for collisional focusing and interference reduction. Argon was used as the collision gas. No other gases were added, as no interfering molecular ions were expected in the relevant mass range for Sb. The sample introduction system consists of a Gilson autosampler, a PolyCon nebulizer and a Cinnabar spray chamber (both Glass Expansion).

Instrumental ICP-MS parameters :

Torch type	Semi demountable torch (HF resistant), 1.8 mm Alumina injector
Spray chamber	Cinnabar (HF resistant)
Nebuliser	PolyCon (Polyimide)
Cones	Ni
Spray chamber temperature	5 °C
Resolution	400
Plasma gases	
Cool gas flow rate	13 L · min ⁻¹
Intermediate gas flow rate	0.90 L · min ⁻¹
Nebuliser gas flow rate	0.89 L · min ⁻¹
Hexapole gas	
Ar gas flow rate	1.5 L · min ⁻¹
Rf power	1350 W
Pump	19 revs/min
Tube	ID: 0.27mm, Wall: 0.91mm, (blue-orange)
Flow rate	140 µL/min
Sample solution	4 % HF and 10% HNO ₃
Rinse solution	3 % HNO ₃
Blank solution	2 % HNO ₃
Sample solution concentration	1 µg/g (Sb concentration)
Ion current	2 · 10 ⁻¹² A (Sb-121)
Autosampler	26 sample positions
Admittance delay	6 min
Rinse delay	6 min
Measurement	50 values per sample

The measurement sequence was unspiked sample, spiked sample, procedure blank and spike. Before and after each sample type as described above a back spike solution was measured three times. More details about the applied IDMS procedure can be obtained from reference [8].

6.3.4 ICP-IDMS analysis

Two independent blank correction methods were applied. The first one is called the procedure blank and corrects for contamination introduced by the sample pretreatment. For this purpose a spike solution was treated like the sample and the blend including the digestion and separation steps. This procedure blank solution was then analyzed like the samples. In the case of a significant contamination through the used reagents the determined

isotope amount ratio in the blank differs from the determined isotope amount ratio in the sample. The amount of the procedure blank can be calculated according to the IDMS equation as shown in [8]. The second blank correction is applied directly previous to the sample measurement. In this case an acid matched solution was used to measure the baselines of the analogue detectors and to compensate for instrumental background. This second blank level measurement also enhances the robustness of the method against cross contamination.

The results of ICP-IDMS measurements are summarised in Table 9. The uncertainty budgets are given in Tables 10 and 11. Only contributions >0.01% have been considered. The agreement between the two samples is very good and the agreement of ICP-IDMS results with RBS and INAA is also well within the stated uncertainties. As with the INAA measurements, the isotope amount ratio differs about 7% from the natural ratio $n(^{121}\text{Sb})/n(^{123}\text{Sb}) = 1.3370$. This deviation is caused by the implantation process of the Sb.

Table 9: ICP-IDMS measurement results

Chip number	Sb atoms (10^{16} cm^{-2})	$n(^{121}\text{Sb})/n(^{123}\text{Sb})$
15.6	4.781 (0.014)	1.4338 (0.0024)
16.3	4.786 (0.014)	
10.4		
17.6		

Table 10: Uncertainty budget for $n(^{121}\text{Sb})/n(^{123}\text{Sb})$ determination with ICP-IDMS

Type		
A	Observed isotope ratio of sample	0.07%
A	Observed isotope ratio of primary assay standard	0.02%
B	isotope abundance of ^{121}Sb (IUPAC-value)	0.09%
B	isotope abundance of ^{123}Sb (IUPAC-value)	0.12%
	Relative combined standard uncertainty u_c	0.17%

Table 11: Uncertainty budget for areal density determination with ICP-IDMS

Type		
B	area of chip	0.10%
B	concentration blank	0.01%
A	observed ratio of blend of sample measurement	0.07%
A	observed ratio of sample of sample measurement	0.07%
A	observed ratio of spike of sample measurement	0.10%
A	observed ratio of backspike of sample measurement	0.02%
A	observed ratio of blend of spike measurement	0.07%
A	observed ratio of spike of spike measurement	0.10%
A	observed ratio of backspike of spike measurement	0.02%
	Relative combined standard uncertainty u_c	0.30%

$$\text{ratio} = n(^{121}\text{Sb})/n(^{123}\text{Sb})$$

6.4 Determination of the depth distribution of Sb with RBS

Fig. 6 shows the results of the determination of the Sb depth profile. The backscattering spectrum in Fig. 6a was taken with 1.5 MeV He⁺ ions. The sample normal was inclined by an angle $\psi = 74^\circ$ with respect to the ion beam to improve the depth resolution. Under these geometrical conditions and with a detector resolution $\Delta E = 16$ keV we obtain a depth resolution of about 15 nm in silicon, which is less than one tenth of the width of the present distribution. At the Si shoulder one can depict the local atomic concentration deficiency of Si due to the thermally formed surface oxide and the implanted Sb. The evaluation of the depth distribution strongly depends on the values of the stopping power of He in Si and SiO₂. The values of Ziegler et al. [4] which are implemented in the code SRIM version 2000 were used. The experimental depth distribution is near Gaussian with a projected range $r = 176$ nm and a straggling $\sigma = 55$ nm. In comparison, the SRIM simulation (see Fig. 6b) gives values of r from 162 to 172 nm and σ from 42 to 46 nm depending on the data base of the stopping power used. Experiment and SRIM simulation are still in fair agreement considering the uncertainty in the knowledge of the stopping power.

The results:

Areal density of the sum of Si, O and Sb atoms in the oxide layer	$(5.9 \pm 0.7) \cdot 10^{17} \text{ cm}^{-2}$
Areal density of the sum of Si, O and Sb atoms in the layer corresponding to the projected range of the Sb distribution	$(9.9 \pm 1.1) \cdot 10^{17} \text{ cm}^{-2}$
Areal density of the sum of Sb and Si atoms in the layer corresponding to the width of the Sb distribution (full width at half maximum)	$(6.5 \pm 0.8) \cdot 10^{17} \text{ cm}^{-2}$

These values are only given for information, since only one method was used for their determination and the uncertainties are rather large. The quoted uncertainties are expanded uncertainties with a coverage factor $k = 2$ and are estimated (type B) assuming upper and lower limits of $\pm 10\%$ to the stopping cross sections used (SRIM version 2000 [4]) for He ions in Si and SiO₂. Thus the stopping cross sections are assumed to lie anywhere within the interval $0.9 \cdot \epsilon_M(E)$ to $1.1 \cdot \epsilon_M(E)$ (rectangular distribution), where $\epsilon_M(E)$ is the SRIM stopping cross section for He ions of energy E in target material M . The thickness of the SiO₂ layer was determined by analyzing the spectrum with the code GISA [6] which was modified to use the stopping cross section values of SRIM [4] version 2000.

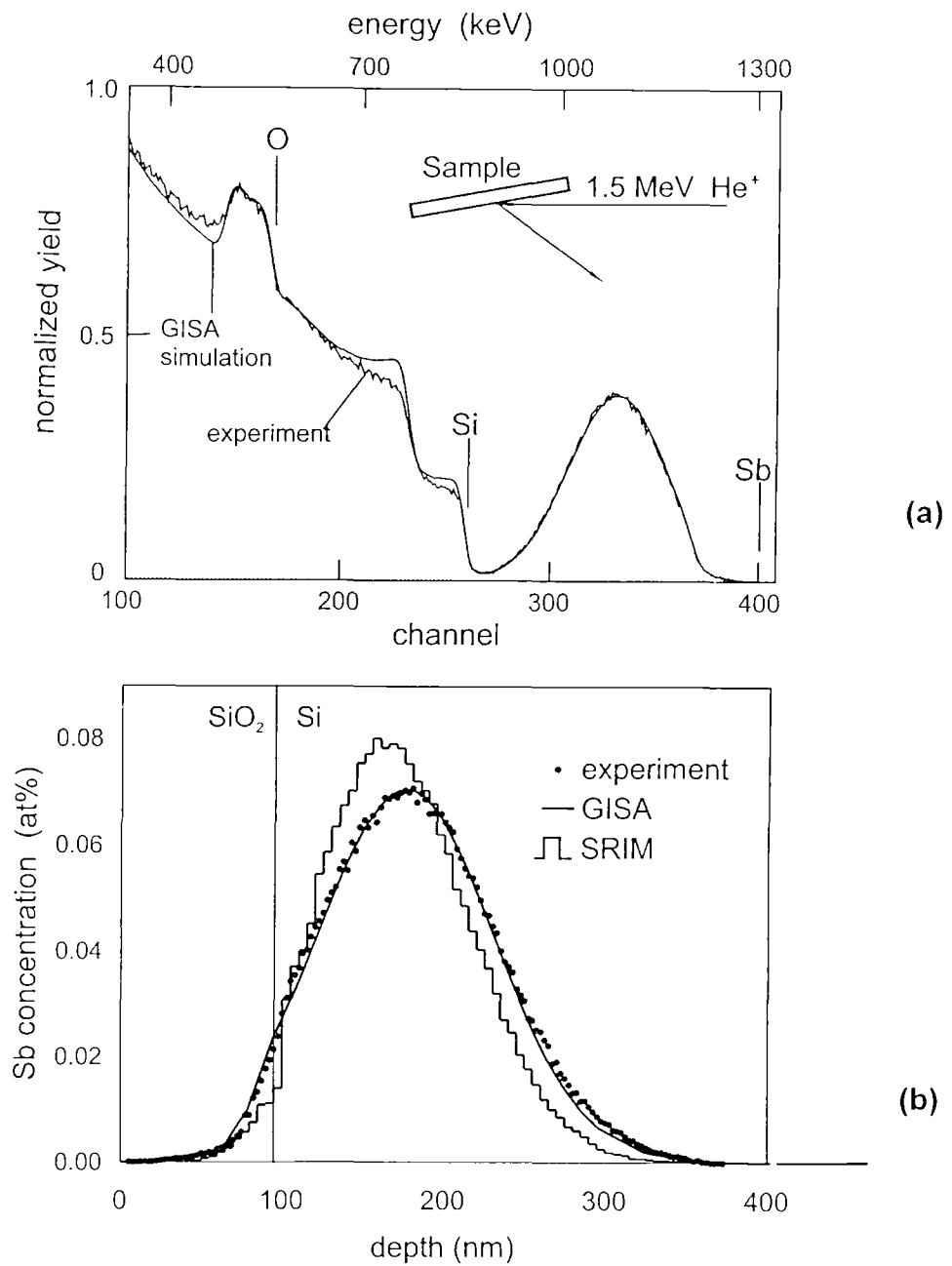

Figure 6: (a) Backscattering spectrum (1.5 MeV He at $\theta=150^\circ$, $\psi_f=74^\circ$). Experimental data and GISA [6] simulation of Sb implanted in Si/SiO₂. (b) Sb concentration depth profile. Experimental data (points), GISA [6] fit to the experiment (line) and SRIM [4] simulation (histogram).

7. SUMMARY OF CERTIFICATION RESULTS

In this section the results of the certification measurements (see Tables 4, 6 and 9) are summarized. Table 12 shows the mean values for the sets of measurements with different methods and in different laboratories. The mean values in the last line of Table 12 are the unweighted means of the mean values of four and two sets of measurements for the areal density and isotopic ratio, respectively. These are the certified values. The figures in brackets are combined standard uncertainties.

Table 12: Mean values of certification measurements for areal density (retained dose) and isotope amount ratio

Analytical method	Sb atoms (10^{16} cm^{-2})	$n(^{121}\text{Sb})/n(^{123}\text{Sb})$
RBS IRMM	4.840 (0.046)	
RBS BAM	4.805 (0.042)	
INAA	4.804 (0.029)	1.435 (0.004)
ICP-IDMS	4.784 (0.014)	1.4357 (0.0024)
Mean values and u_{cert}	4.808 (0.027)	1.4353 (0.0028)

The combined standard uncertainty u_{cert} of the certified values is calculated with equation (2) after Ref. [9]:

$$u_{cert} = \sqrt{(u_{char})^2 + (u_{inhom})^2} \quad (2)$$

where u_{char} is the characterization uncertainty from the reported values. u_{inhom} replaces the conventional inhomogeneity contributions u_{bb} and u_{wb} , and u_{lts} , the uncertainty of long-term stability, is set to 0 due to the known stability of this material under suitable storage and measurement conditions (see section 5).

Special attention has to be given to the partial dependence of the RBS measurements. Thus, u_{char} is calculated according to equation (3) [9]

$$u_{char} = \sqrt{u_c(I)^2 + u_c(III)^2} \quad (3)$$

where $u_c(I)$ is the contribution from exclusively laboratory-dependent uncertainties and relates to the uncertainty of the results of n laboratories as given in equation (4) [9,10]

$$u_c(I) = \frac{\sqrt{\sum_{i=1}^n (u_{c,i})^2}}{n} \quad (4)$$

It has to be noted that the four combined uncertainties $u_{c,i}$ refer to completely independent observations, there are no common sources of uncertainty included in these.

$u_c(III)$ denotes combined uncertainties common to groups of laboratories [10]

$$u_c(III) = \sqrt{\frac{\sum_{q=1}^g h_q \cdot u_c(q)^2}{g \cdot l}} \quad (5)$$

with the group identification number q , the number of laboratories h_q in this group, the total number of groups g and total number of laboratories l . $u_c(III)$ consists only of the common uncertainty component of the RBS results, since the INAA and ICP-IDMS results are completely independent (their $u_c(q) = 0$). $u_c(III)$ is thus calculated with $h_q = 2$, $g = 3$, $l = 4$ and $u_c(q)^{rel} = 0.75\%$. Similarly, for $n(^{121}\text{Sb})/n(^{123}\text{Sb})$ the uncertainty in the IUPAC value (relative 0.15 %) is common to both methods INAA and ICP-IDMS ($h_q = 2$, $g = 1$, $l = 2$).

The uncertainty contribution u_{inhom} from the inhomogeneity of the areal density is taken to be the standard deviation of the homogeneity measurements with SY-XRF (performed with a beam of 0.3 mm x 0.4 mm, see section 4: $u_{inhom}^{rel} = 0.38\%$), and is neglected in the case of the isotope amount ratio measurements. Thus the certified values are valid for areal density determinations in fractions of the chip surface down to spot sizes of 0.3 mm x 0.4 mm.

In Figures 7 and 8 the error bars indicate the combined uncertainty u_c of each laboratory's mean value. The lines indicate the mean values and the interval $\pm u_{cert}$. All values overlap well with this interval.

In the certificate the uncertainties are given as expanded uncertainty

$$U_{CRM} = k * u_{cert}$$

with a coverage factor $k = 2$, corresponding to a level of confidence of approximately 95%, and the combined standard uncertainty u_{cert} of the certified values.

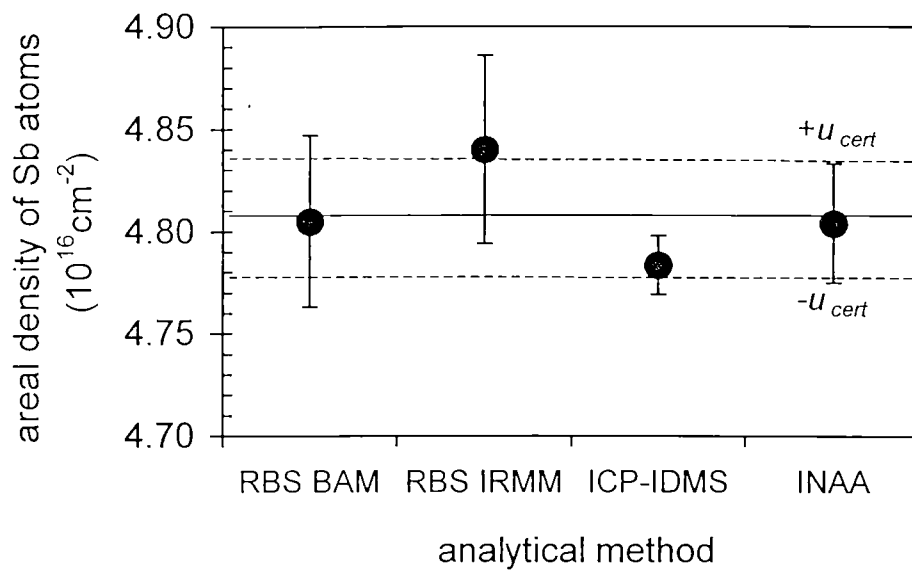

Figure 7: Results of certification measurements for areal density of Sb

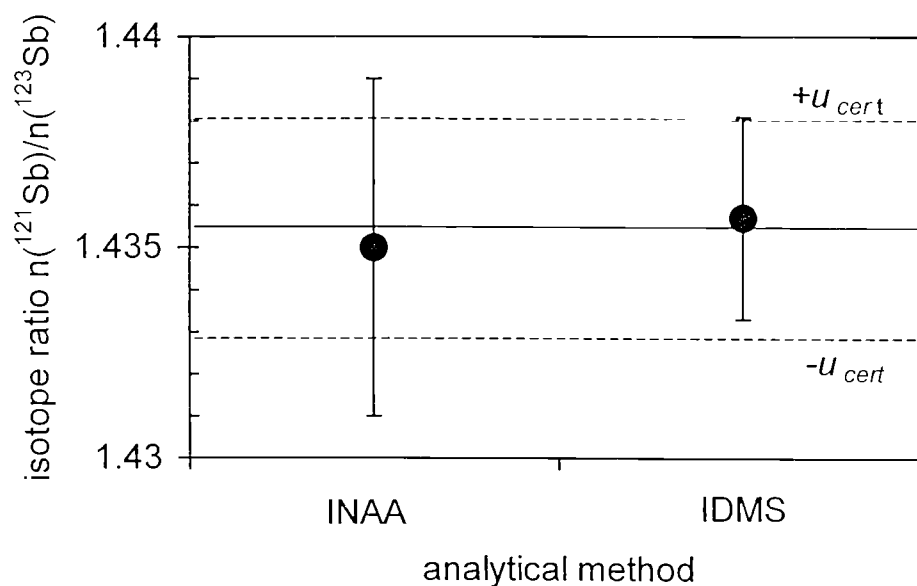

Figure 8: Results of certification measurements for isotope amount ratio

8. INSTRUCTIONS FOR USE

Diffusion of the implanted Sb atoms could change the implantation profile. It is therefore recommended to keep the reference layers below 150°C.

A minimum spot size of 0.15 mm² (0.2 mm in diameter or equivalent) should be taken for analysis. If smaller sizes are used, a sufficient number of different positions must be analyzed in order to ensure representative sampling.

Acknowledgement:

We thank C. Dücső of the Research Institute for Technical Physics and Materials Sciences (MFA) of the Hungarian Academy of Sciences for supplying the thermally oxidized silicon wafers used for this CRM.

9. REFERENCES

- [1] Guide to the Expression of Uncertainty in Measurement, ISO, ISBN 92-67-10188-9, 1993
- [2] U. Wätjen, H. Bax and P. Rietveld, *Surface and Interface Analysis* 19 (1992) 253-258
- [3] U. Wätjen, in: *Application of Particle and Laser Beams in Materials Technology*, Editor: P. Misaelides, Kluwer Academic Publishers, Dordrecht, 1995, p. 477-484
- [4] J.F. Ziegler, J.P. Biersack and U. Littmark, *The Stopping and Range of Ions in Solids*, Pergamon, New York, 1985
- [5] *Handbook of Modern Ion Beam Materials Analysis*, Editors: J.R. Tesmer, M. Nastasi, J.C. Barbour, C.J. Maggiore and J.W. Mayer, Materials Research Society, Pittsburgh, 1995
- [6] J. Saarihahti and E. Rauhala, *Nucl. Instr. and Meth. B* 64 (1992) 734-738
- [7] D. De Soete, R. Gijbels and J. Hoste, *Neutron Activation Analysis*, in: *Chemical Analysis Vol. 34*, Wiley Interscience, London, 1972
- [8] P. Klingbeil, J. Vogl, W. Pritzkow, G. Riebe and J. Müller, *Anal. Chem.* 73 (2001) 1881-1888
- [9] T.P.J. Linsinger, J. Pauwels, H. Schimmel, A. Lamberty, A.M.H. van der Veen, G. Schumann and L. Siekmann, *Fresenius J. Anal. Chem.* 368 (2000) 589-594
- [10] J. Pauwels, A. Lamberty and H. Schimmel, *Accred. Qual. Assur.* 3 (1998) 180-184
- [11] S. M. Sze, *Physics of Semiconductor Devices*, Wiley Interscience, New York, 1981
- [12] International Union of Pure and Applied Chemistry, *Pure & Appl. Chem.* 70 (1998) 217-235, *Pure & Appl. Chem.* 68(1996) 2339-2359



Mission of the JRC

The mission of the JRC is to provide customer-driven scientific and technical support for the conception, development, implementation and monitoring of EU policies. As a service of the European Commission, the JRC functions as a reference centre of science and technology for the Union. Close to the policy-making process, it serves the common interest of the Member States, while being independent of special interests, whether private or national.



EUROPEAN COMMISSION
JOINT RESEARCH CENTRE