



BAM

Bundesanstalt für
Materialforschung
und -prüfung

**Study of the failure limits of a railway tank car filled
with liquefied petroleum gas subjected to an open
poolfire test.**

Final report

Contract no. 01A0100001

Start of work: 15.01.2001, End of work: 31.03.2001

Report no. 01A0100001

Exam. Agreement No. 100001, Date of Agreement: 15.01.2001

Examined by:

Federal Institute for Materials Research and Testing

Division 10.1

Technische Universität Berlin, Institut für Materialwissenschaft



Research and development projects

"Study of the failure limits of an undergrate-fired railway tank car filled with liquefied petroleum gas"

Final report

Contract awarded by:

Saxon Ministry of State for Environment and Agriculture

represented by the

Saxon Administrative Office for Environment and Geology

Executed by:

Federal Institute of Material Research and Testing (BAM)

Specialist Group III.2

"Dangerous-goods tanks and accident mechanics"

Contract dated: 14 April, 1998

Assignment notification dated: 12 May, 1998

BAM project number: 3215

Responsible for content:

Dr.-Ing. Christian Balke

Dipl.-Ing. Winfried Heller

Dr.-Ing. Rainer Konersmann

Dipl.-Ing. Jörg Ludwig

Project leader: Dr.-Ing. Christian Balke

Federal Institute for Materials Research and Testing (BAM)

12200 Berlin, 13 September, 1999

Division III.2
Tanks for Dangerous Goods and
Accidental Mechanics

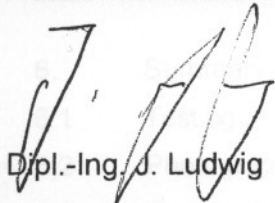

Dipl.-Ing. J. Ludwig

Section III.22

Storage Tanks; Tank Farms



Dr.-Ing. Ch. Balke

Table of contents

	Page
Preface: Assistance obtained for preparing and conducting the tests	1
1. Introduction	3
2. Objective of the project	3
3. Description of the test premises	5
4. Consideration of external effects	8
4.1 Radius of the fireball during a BLEVE	8
4.2 Duration of the fireball	8
4.3 Estimate of the thermal radiation of the fireball	8
4.4 Estimate of possible pressure damage	9
4.5 Risk of injury to persons due to overpressure	12
4.6 Estimate of flying debris	13
5. Measures to ensure safe progress of the tests	13
5.1 Structural measures	13
5.1.1 Design of the fire stand	13
5.1.2 Protected shelters for visitors	18
5.1.3 Protection for camera sites	19
5.2 Organizational measures	20
5.2.1 Outside of the test premises	20
5.2.2 Within the test premises	22
6. Summary of the test results	23
6.1 Test rig	23
6.2 Photographic and cinematic documentation; observation sites	23
6.3 Test method	23
6.4 Short overview of the most essential test data	25
7. Conclusions	25
8. Literature	28
9. Appendix: Test report	

Preface

Assistance obtained for preparing and conducting the tests

Large-scale test projects such as the one described in this Research Project Final Report on the "Study of the failure limits of an undergrate fired railway tank car filled with liquefied petroleum gas" require an immense effort with respect to logistics and material both during the preparatory stage as well as during the performance of the actual tests. This effort cannot always be rendered single-handedly nor can it - due to limited financial means - always be accomplished by outsourcing.

The authors therefore wish to use this space here to express their gratitude to the departments, authorities and institutions listed below for the smooth support that they have rendered.

1. Federal Ministry of Defence (BMVg)
 - Federal Armed Forces:
 - 4th Potsdam Corps
 - Special Corps of Engineers 800
 - Military District Command VII
 - 13th Armoured Infantry Division
 - 1st Transport Battalion 134
 - Army liaison and reconnaissance flying squadron 400
 - Engineers Brigade 80
 - Logistics office of the Federal Armed Forces
 - 24th Armoured Infantry Division
2. Federal Border Guard Committee East
3. Administrative district Teltow-Fläming, offices of the municipal authorities
4. Police headquarters Potsdam, protection area Teltow-Fläming
5. Federal forestry office Neubrück
6. Fire departments of the following administrative districts and towns:
 - Baruth
 - Gottow
 - Sperenberg
 - Jüterbog
 - Luckenwalde
 - Merzdorf
 - Horstwalde
7. Munitions dissection operations of the state of Brandenburg
8. The promoting organization Horstwalde Traffic Testing Facility
9. Horstwalde forest wardens office
10. Sperenberg senior forestry office
11. Association for nuclear service m.b.H. (GNS)
12. Association for nuclear containers m.b.H. (GNB)

13. Federal Institute of Material Research and Testing (BAM)
- | | | |
|------------------|--------|--|
| Specialist Group | S.3 | Construction of scientific equipment |
| | S.31 | Development and design |
| | S. 32 | Experimental workshops for equipment and specimens |
| | Z.6 | Internal services |
| Specialist Group | III.3 | Safety of tanks for transport and storage |
| Department | II.301 | BAM-THW |
| | III.33 | Containers for interim and final storage of radioactive substances |
| | Z.011 | Technical emergency service (TND) |
| | Z.644 | Horstwalde |

It is through the supportive measures provided by the above divisions that it was possible, on the one hand, to implement the necessary structural measures and, on the other hand, to carry out the organizational measures required on the day of the test, and thus to perform the test successfully.

At this point the authors also consider it absolutely necessary to mention that it was through the unbureaucratic assistance provided by the Federal Minister of Defence and consequently that of the Federal Armed Forces as well as the responsible administrative districts, municipalities and offices of municipal authorities that it was possible to conduct a test of this kind within the available time.

1. Introduction

Within the framework of the research project promoted by the Saxon Ministry of State for Environment and Agriculture (SMUL) (Reference: 13-8802.3521140), on April 27, 1999 a test was conducted on the BAM test premises in Horstwalde, administrative district Teltow-Fläming, in the Federal State of Brandenburg, during the course of which a 45 m³ railway tank car filled approximately 22% with liquefied petroleum gas was subjected to a fire test in which the railway tank car failed 17 minutes after commencement of the test (15 minutes after the fire had formed) (BAM Test Report No. III.2/9907 dated 30.06.1999).

Due to the uniqueness of such a test, which to the knowledge of the authors had never before been performed in this manner in Germany or in Europe as a whole, the Saxon State Ministry agreed to provide in addition to the railway tank car a Castor of the type THTR/AVR (without this having been part of the original project), which was also to be subjected to a fire. This report only deals with the test results of the Castor container where they are relevant to the overall project.

A detailed evaluation of the effects on the Castor container will be carried out by the BAM (Specialist Group III.3 "Safety of tanks for transport and storage").

2. Objective of the project

It is adequately known that, compared with other fossil fuels such as coal or fuel oil, liquefied petroleum gases in compliance with DIN 51622 /1/, in other words, commercially available technical grade gases of the C₃ and C₄ hydrocarbons propane, propylene (propene), butane, butylene (butene) and other mixtures, behave in a more environmentally compatible way.

This has led to the situation that liquefied petroleum gas in the above sense is also being increasingly used as fuel both privately as well as in the commercial sector.

Consequently we have seen in the past, inevitably higher transport and trade activities, which have also led to an increase in storage capacities. Transportation is accomplished for the most part with railway tank cars (RTC), road tank vehicles (RTV) as well as by means of tankers.

To supply the population with LPG for domestic use and businesses for commercial use - particularly in rural areas in which other fuels are not adequately available in the right type (electricity, natural gas), or where for reasons of environmental protection and the type of handling they are no longer used (coal, wood, peat) - their distribution to the above named consumers is inevitably accomplished with RTVs approved in compliance with road traffic regulations, and these are then either filled at stationary distribution depots or at so-called RTC transfer stations.

At the distribution depots liquefied petroleum gas is distributed from fixed (stationary) storage containers, while at the transfer stations distribution takes place from mobile railway tank cars. The transfer stations are generally located in track areas specially assigned for this purpose. To ensure the safe handling of liquefied petroleum gas, but also to protect third parties, animals, material assets and the environment, it is necessary to adhere to defined safety engineering principles.

These are not always the same for both distribution depots and transfer stations.

Distribution depots for liquefied petroleum gas with a capacity of more as 3 tons are subject to regulations governed by the Federal Air Pollution Laws (BImSchG)/2/ or the Major-accident Regulations (12th BImSchV) /3/; they must thus be built and operated in compliance with state-of-the-art safety engineering. The corresponding federal state authorities are responsible for the resulting requirements and/or their implementation.

However, because of the general railway laws, railway tank car transfer-stations are subject to a plan-approval procedure in which the responsibility for approvals lies with the Federal Railway Office (EBA). Although legislature requires that the state authorities are tied into these procedures, the EBA is however not tied to any possible recommendations made by the states. This is the basis upon which railway tank car transfer-stations are built and operated in

compliance with state-of-the-art engineering.

Therefore there currently exist differences in the safety engineering requirements of stationary distribution depots - which are built in compliance with the Major-accident Regulations - and the railway tank car transfer-stations.

This particularly applies to the area of fire protection. In designing fire-protection measures, it is decisive to determine what type of fire hazard is to be covered for a transfer station or a distribution depot, so that adequate protection against overheating is provided for the railway tank car and/or the storage container and also the road tank vehicle to prevent a possible container failure.

Although there may be broader safety engineering aspects that may be technically and organizationally better implemented in individual transfer processes, the main safety engineering difference between distribution depots and transfer stations is the application of adequate fire protection measures. Safety-engineering aspects of a more far-reaching kind, which relate to the transport containers of railway tank cars or also to road tank vehicles themselves and to their possible failure, e.g. due to overfilling, material defects, etc., apply in a comparable manner to both the distribution methods discussed, however these are not dealt with within the scope of this research project.

According to the state of the art of safety engineering (Major-accident Regulation) as well as the state of the art of engineering (Pressure-Vessel Regulation), adequate fire protection is considered implemented in the sense of a technical measure when containers in storage plants are provided with an earth covering of 1 m thickness.

In the individual case, adequate fire protection is also considered implemented when container surfaces are provided with a protective coating whose suitability or effectiveness has been proven and whose reliability has been defined as preventing container failure for a period of 90 minutes under fire conditions.

Under certain boundary conditions, comparable protection can also be provided by appropriately designed water-sprinkler or water-submergence facilities when technical reasons make it impossible to provide an earth covering or a vessel coating.

Where an earth covering is provided, undergrate firing or the direct firing of a storage container is excluded. Because of these circumstances, both the BAM as well as the Saxon Ministry of State for Environment and Agriculture derive the requirement, that alternative measures must also ensure that a container - irrespective of whether it is being used as a storage container in a distribution depot or a railway tank depot or a road tank vehicle in a transfer station - must be adequately protected against direct firing and/or undergrate firing for a certain time.

These directly acting fire-protection measures must be supplemented by additional facilities (e.g. gas-warning devices, fire-reporting systems, facilities for passing on alarm reports, alarm planning, emergency planning, structural measures etc.). This aspect attains special significance when railway tank car transfer-stations are located directly next to railway tracks serving passenger transport or next to other objects worthy of protection.

Although these safety engineering concepts are shared by several state authorities and have already found their way into corresponding decrees, e.g. joint decree by the Social and Environmental Ministry in Lower Saxony /4/, so far no adequate discussions have been held; rather, fire-protective measures that are not in compliance with state-of-the-art safety engineering and state-of-the-art engineering for storage tanks are still applied to railway tank vehicle transfer-stations.

Since the end of the 1980's, BAM has conducted numerous fire tests on small (4.85 m³), unprotected, water sprinkled LPG-containers provided with protective insulation.

At that time it was found that unprotected containers of the above-mentioned dimension (see also section 4.6) could fail within a period of approx. 7 - 12 minutes.

These tests also delivered the insight that "water sprinkling" measures for fire-fighting require a sprinkling rate ranging from 400 to 600 l/m²h to ensure that this measure could be considered an adequate alternative to coverings with earth.

Many times both in the past and present it has been stated in this respect that, due to their design in compliance with traffic regulations, e.g. greater wall thicknesses, higher test pressure, etc., railway tank cars behave more favourably in a fire condition than comparable storage tanks. This circumstance should therefore be taken into account in fire-protection measures, i.e. the requirements with regard to the sprinkling rates could not be transferred 1:1 to larger containers and could be considerably reduced.

Research into the heating-up behaviour and the failure limits of a large container was thus an essential safety engineering objective of this project. Furthermore, the test was to be used to evaluate the approximation methods recommended in literature with respect to the action radii, the purpose being to gain broader knowledge with regard to disaster control.

3. Description of the test premises

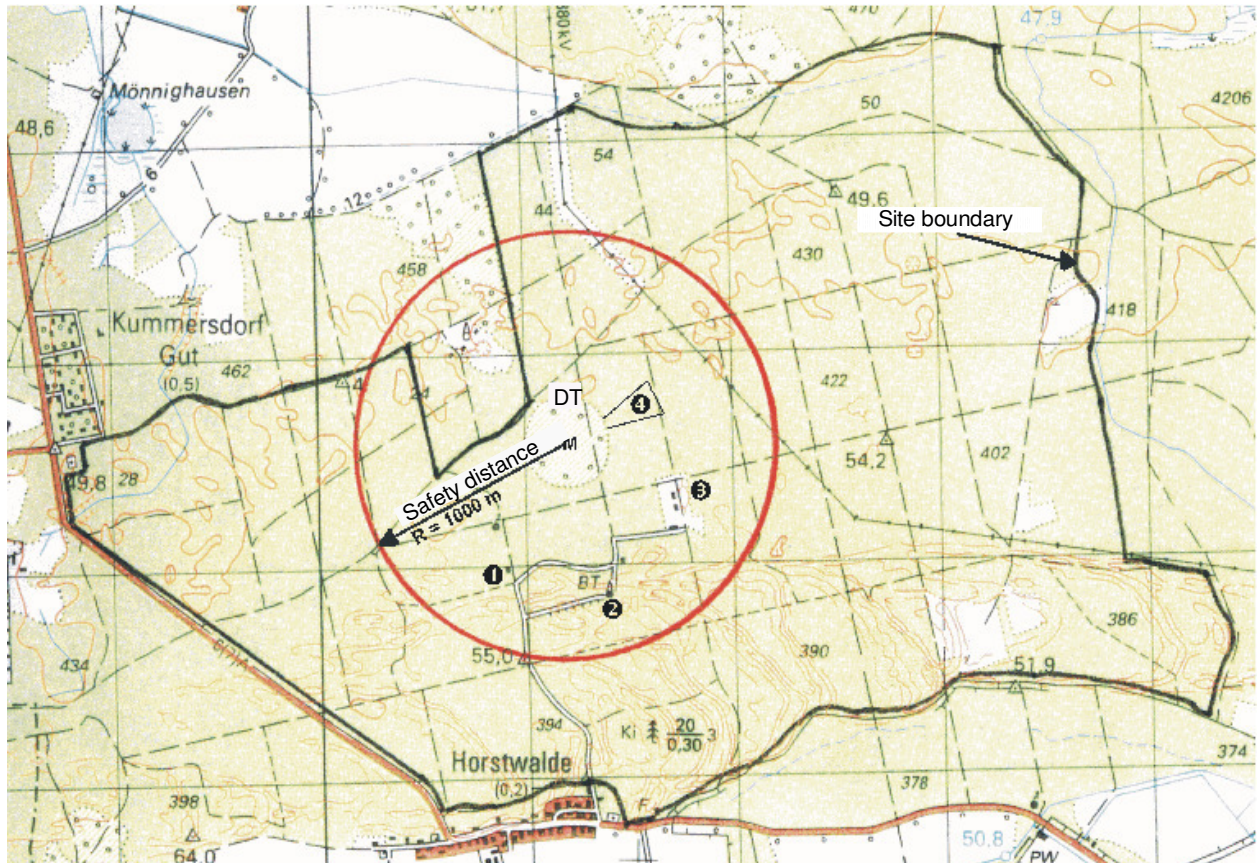

BAM's 1200 hectare open test ground is located approx. 60 km south of Berlin, in Brandenburg State's Teltow-Fläming administrative district. It is bordered to the south by a terminal moraine of the Baruther Glacial Valley, in the east by Mueckendorfer Heath and in the north by Neuendorfer Heath. West of the test ground, approx. 2000 m away, there is the village Kummersdorf-Gut, while the village Horstwalde (see map section) borders the area in the southerly direction.

The area is characterized by the pine forests that are typical of Mark Brandenburg; these pine forests completely surround the blast area (400 m diameter). Approx. 130 m away from the mid-point M of the blast area, there is a 17.5 m high drop tower DT. This consists of two steel tubes connected by a cross-member, Fig. 3.1.



Fig. 3.1: View of the fire stand under construction; the drop tower is seen at the back

A two-storey administrative building (1), which provides protected accommodation to visitors and technical assistants, is located approx. 600 m from the mid-point of the blast area (Fig. 3.2).



Fig. 3.2: Administrative building (1)

A further prominent point in the area consists of two grade tracts (2) on which there is, for example, a fire lookout tower. The distance to the mid-point of the blast area is approx. 650 m. During the test, armour-plated containers were installed here to serve as accommodation for visitors and as a communications office (Fig. 3.3).



Fig. 3.3: The plated-plated visitor containers on the grade tracts

The exhibition grounds and the open test area (3) are located approx. 550 m from the mid-point M. The sheds located there are designed as light-weight structures (Fig. 3.4).



Fig. 3.4: Light-weight sheds on the open test area (3)

The entire blast area is surrounded by an earth embankment approx. 2 m high.

In the north-easterly direction there is a wedge-shaped forest break - the so-called "swallow tail" (4). Here there is a ground bunker, which was used to accommodate the measuring instruments and the test team during the course of the test. The distance to the mid-point M of the blast area is approx. 500 m.

The following aerial photo (Fig. 3.5) provides a good overview of the test ground.



Fig. 3.5 The test ground seen from the air; for details of the labelled points, please refer to the text.

4. Consideration of external effects

As was already mentioned in section 3, the blast area is surrounded by a pine forest in which there are further "sensitive" building structures. For this reason it was necessary to determine the action radii of such an experiment. This is of particular concern with respect to the radiation load on the forest, the effect of blast waves with respect to broken glass, structural damage to buildings and, last not least, stress for the human eardrum (deafness by shock waves).

An estimate of the action radii in accordance with /5/: showed the following results:

4.1 Radius of the fireball during a BLEVE

$r = 29 \times M^{1/3}$ (formula in compliance with the International Labour Office, ILO, 1989)

whereby

r = radius of the fireball [m]

M = mass of the propane [t]

$r = 29 \times 5^{1/3}$; $r = 49.6$ m

4.2 Duration of the fireball

$t = 4.5 \times M^{1/3}$ [s] (in compliance with ILO)

$t = 4.5 \times 5^{1/3}$; $t = 7.7$ s

4.3 Estimate of the thermal radiation of the fireball

$q_t = E \times F \times T$

whereby

q_t = heat radiation incident at a point [kW/m²]

E = strength of the surface radiation [kW/m²], which in this radiation model (cylinder) is assumed to be 270 kW/m²

$$F = r^2 \cdot \frac{R}{(R^2 + r^2)^{3/2}}$$

whereby r = radius of the fireball [m]

R = distance between container and assumed impact point [m]; this is assumed as

$R = 200$ m (radius of blast area)

T = conductivity of air in the formula

$$T = 1 - 0.058 \cdot \ln R$$

$$T = 1 - 0.058 \cdot \ln 200 = 0.69$$

The results of this estimate yield:

$$q_t = 10,4 \text{ kW/m}^2$$

$$Q = q_t \cdot t = 10.4 \cdot 7.7 = 80.1 \text{ kJ / m}^2$$

According to /6/, where there is a heat flux density upwards of 120 kJ/m^2 , it can be assumed that organic substances will ignite.

Furthermore, it was necessary to take into account, that it cannot be excluded, that hot metal fragments scattered into the dry undergrowth, would trigger secondary fires. In earlier BAM-BLEVE tests /7/, it was found that pine needles on debris fragments were scorched. This observation agrees with a damage report published in the USA (Stockton, 16.05.1986) in which the BLEVE of an 1892.5 l liquefied gas storage container is described as follows: "Hot metal fragments, some as large as a basketball, were propelled on to the roofs of homes two blocks away. The burst hot metal triggered several grass fires "/8/.

Where test procedure scheduling needs to take climatic conditions into account, this is linked to considerable uncertainty factors; it thus became necessary to take suitable preventive measures to ensure that the test could be conducted even under unfavourable conditions (dryness, wind), i.e. it was necessary to provide corresponding fire-fighting facilities and to observe the test from the air.

4.4 Estimate of possible pressure damage

According to /5/, blast-pressure damage can be estimated with the following formula, although it should be noted, that this relationship applies to the more seriously classified vapour cloud explosion (VCE).

$$R = C \cdot W^{\frac{1}{3}}$$

whereby

R = maximum range of the blast wave [m]

C = constant [m/kg] (see table 1)

W = mass of gas released in kg

Damage occurrence (human)	Damage occurrence (material)	C
-	Occasional breakage of glass panes	100 - 50
Temporary damage to hearing	Breakage of glass panes	50 - 20
Falling down	Repairable damage to buildings	20 - 11
Bursting of the eardrum	Severe damage to buildings in industrial plants	11 - 5.5
From long-term injuries to death	Total devastation	5.5 - 0.85

Table 1: Overview of C-values when damage occurs (from /5/)

With an applied propane mass of 5000 kg, the following action radii had to be assumed:

occasional glass panes	up to 1700 m
breakage of glass panes, temporary damage to hearing	855 m
repairable damage to buildings, humans are hurled over	342 m
severe damage to buildings in industrial plants, bursting of the eardrum	189 m
Total devastation, long-term injuries, death	94 m

At the following distances:

Mid-point of blast area up to the exhibition grounds, approx. 550 m,

Mid-point of blast area up to grade tracts/winch house/fire lookout tower, approx. 650 m and

Mid-point of blast area up to the administrative building, approx. 600 m

It was to be expected that the blast wave would cause no damage to the buildings constructed with masonry and/or prefabricated concrete parts.

According to this estimate, preventive measures had to be taken against broken glass, e.g. opening windows and doors. Because of the ridge between the blast area and the access road, the Horstwalde settlement was less endangered by the blast wave; the distance between the mid-point of the blast area and Horstwalde is approx. 1700 m.

Ear-protector caps were issued to persons present within a radius of 1000 m (test staff, guests).

As this estimate applies to a vapour cloud explosion (VCE) (already mentioned above), i.e. it delivers conservative values, another method of estimating pressure damage was examined /6/.

In this case, however, it must be considered that this method of estimation does not take the mass of the propane into account and that the internal pressure p_i (i.e. the bursting pressure) must be estimated.

In earlier BLEVE tests conducted by BAM, the bursting pressure was almost twice the allowable test pressure (e.g. Test 1.5/399: 20.3 bar test pressure, 39 bar bursting pressure). If it is assumed that this trend will also be found on larger containers with a greater wall thickness, then the bursting pressure of the railway tank car p_i (test pressure 28 bar) can be assumed as 56 bar.

According to /6/ the energy released during explosions can be estimated as follows:

$$E_0 = p_i \cdot V_B \left[\ln \frac{p_i}{p_u} - 1 + \frac{p_u}{p_i} \right] \quad (1)$$

whereby

p_i = internal pressure [Pa] \approx assumed as 56 bar = 5.6×10^6 Pa (Nm^{-2})

p_u = atmospheric pressure \approx taken as 750 Torr = 10^5 Pa

V_B = volume of container [m^3] \approx RTC with 45 m^3

$$E_0 = 5.6 \cdot 10^6 \text{ Nm}^{-2} \cdot 45 \text{ m}^3 \cdot 3.04 \text{ [J]}$$

$$E_0 \sim 7.6 \cdot 10^8 \text{ J}$$

Because of the necessary fracturing work and the delay in release, only 60 % of E_0 is released, i.e. $E \sim 0.6 \times E_0$;

$$\mathbf{E \sim 4.6 \cdot 10^8 \text{ J}}$$

The peak pressure on an object at a distance x from the burst centre is estimated as:

$$\Delta p = p_u \left[\frac{7 \cdot q}{x^3} + \frac{2,7 \cdot q^{0,66}}{x^2} + \frac{0,84 \cdot q^{0,33}}{x} \right] \text{ [Pa]} \quad (2)$$

With

$$q = \frac{E}{4,3 \times 10^6} \quad (3)$$

$$\mathbf{q \sim 107 \text{ J}}$$

we obtain from (2):

$$\Delta p = 10^5 \left[\frac{7 \cdot 107}{x^3} + \frac{2,7 \cdot 107^{0,66}}{x^2} + \frac{0,84 \cdot 107^{0,33}}{x} \right] \text{ [Pa]}$$

$$\Delta p = 10^5 \left[\frac{749}{x^3} + \frac{59}{x^2} + \frac{3,9}{x} \right] \text{ [Pa]}$$

At a distance of $x = 550$ m (lightweight construction sheds on the exhibition grounds), the maximum peak overpressure reaches a value of $p = 729$ Pa. ~ 0.007 bar. Bussenius reports the pressure/damage relationships shown in Table 2.

Peak overpressure p [bar]	Action
< 0.03	harmless
0.03 – 0.05	light damage to wooden and multi-storey stone buildings
0.05 – 0.10	light damage to roofs, metal and reinforced concrete structures, wooden bridges
0.1 – 0.3	medium destruction to brick buildings, metal constructions, wooden bridges
0.4 – 0.8	total destruction to industrial buildings, pipe bridges etc. must be expected
> 0.7	human deaths are possible
1.0 – 2.0	Overhead power lines, concrete bridges, transformer stations are destroyed

Table 2: Action of peak overpressures to buildings and facilities

From the preceding estimates it can be seen that damage to the lightweight construction sheds was highly improbable.

According to /9/, broken window panes must be expected upwards of 0.02 bar overpressure, and commencement of minor structural damage upwards of 0.025 bar. From 0.15 to 0.31 bar,

wall panelling of buildings may be destroyed.

Further distance/action relationships quoted in literature are based primarily on TNT-equivalence methods, i.e. based on the knowledge of pressure actions resulting from tests with explosives, the attempt is made to derive corresponding actions that would result from explosions with propane gas clouds.

Deriving this relationship via a TNT equivalent is however controversial, since TNT-explosions show different time and pressure characteristics ("shorter and harder"). Nevertheless the method is often used because in numerous explosive experiments the effects on buildings and humans have been very well documented.

An estimate of the action radii based on a TNT-equivalent model (also for VCE) shows that with an energy input of 5 t of propane overpressures of 14-22 mbar can be expected at distances between 500 and 700 m.

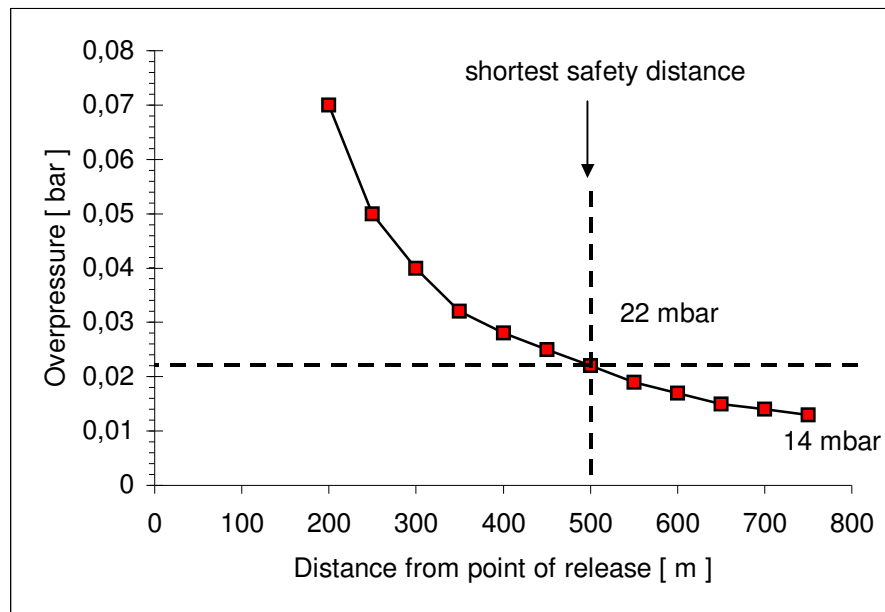

Fig 4.1: Overpressure in dependence of the mass of gas; TNT-equivalent model

According to /9/, the 0.021 bar boundary describes a safe distance at which there is also no likelihood of fragment action.

4.5. Risk of injury to persons due to overpressure

According to Leiber /9/, the human eardrum suffers damage from approx. 0.3 bar upwards. Using formula (2), the overpressure at the visitor site (distance approx. 650 m) calculates to approx. 0.006 bar. Although there appeared to be no risk of damage to the human eardrum, ear-protector caps were issued to all persons located within a radius of 1000 m because, at an overpressure of approx. 6 mbar and an active period of approx. 8 s, a sound pressure level of approx. 147 dB was to be expected (sound-level limit for avoiding hearing impairments, WTD 91, Meppen). As the sound-stress capacity of the human ear also depends on the respective person's constitution (blood pressure, psychic condition), this was required to reliably avoid deafness due to shock waves.

The Horstwalde settlement is located approx. 1700 m away. At this distance the max. peak overpressure is 0.002 bar, as determined with formula (2). Because a mountain ridge screens the village, broken glass or personal injuries resulting from splinter action were not to be expected in the surrounding settlement areas. The Kummersdorf-Gut settlement is located approx. 2000 m away.

The test team took its place in an underground bunker at the end of the swallowtail, at a distance of approx. 500 m; the peak overpressure calculated with (2) for this point was approx. 0.007 bar.

4.6 Estimate of flying debris

The estimate of flying debris (with respect to flight distance and the mass of the scattered parts) can only be derived with simplified assumptions. By observing the organizational /technical measures, however, injuries to persons due to flying debris could be excluded to a very high degree. For this purpose, the following considerations were made:

The debris flight distances shown in the following tables were derived from tests conducted by the BAM using 4.85 m³ containers that were undergrate fired with heating oil (filled 50% ~ 1.2 t).

Test No.	1.02/347	1.5/400	1.5/399
Date	14.10.82	12.12.83	24.11.83
t _{BLEVE} [min]	11.2	9.0	7.3
p _{BLEVE} [bar]	24.5	30.5	39
DF _{max} [m]	140	370	370 through 400

Table 3: Maximum debris flight distances DF_{max} (determined by BAM)

The maximum debris flight distance is derived with:

$$TF_{\max} = \frac{v_o^2 \sin 2 \alpha}{g}$$

The greatest debris flight distance is reached when $\alpha = 45^\circ$, so that $DF_{\max} = v_o^2/g$, i.e. for a known flight distance the velocity v_o [m/s] the debris can be estimated. In the above tests these were between 37 and 63 m/s. Assuming that it is mainly the burst pressure that influences the flight distance, and that a linear relationship can be assumed, the RTC tests - in which a bursting pressure of 56 bar had been estimated - will trigger debris speeds of approx. 90 m/s leading to a maximum debris flight distance of approx. 825 m.

This is also a reason why all persons involved and who were located within a radius 1000 m were kept under cover (armoured container, underground bunker, administrative building). It was also not possible to exclude that local nests of fire might erupt, particularly since the forest ground was extensively covered with dry undergrowth. The provision of an adequate number of tank fire engines was therefore absolutely necessary. With the help of helicopter observation, finding fragments or localizing fire nests presented no problem.

To minimize the probability of flying debris or a "rocket effect" caused by a separated container bottom, the fire stand was surrounded by corresponding embankments, which could either hold back fragments or dissipate their kinetic energy (see section 5.1).

5. Measures to ensure safe progress of the tests

5.1 Structural measures

5.1.1 Design of the fire stand

While setting up the fire stand it was necessary to take into account that it would only be possible to establish a credible scenario with the help of an open fuel-oil fire. Although this meant causing a limited amount of environmental damage, it was not avoidable in this case. Because of the action radii and the existing facilities (drop tower, earth-covered cables) in the blast area, the fire stand was displaced approx. 30 to 40 m out from middle of the area in a south-westerly direction. This resulted in a closer distance to the edge of the forest in a westerly direction. In planning the action positions of the tank fire engines it was thus necessary to account for this.

The open side of the earth embankment pointed in the direction between the drop tower and

the "swallowtail", a direction in which there were no sensitive objects.

Work was commenced by installing the slab foundations. For this purpose concrete slabs measuring 3 x 1 x 0.2 m were placed on-end in a 0.2 m deep trench, so that initially a U-shaped semi-enclosure measuring 15 x 15 m by 0.8 m high was formed (see Fig. 5.1).



Fig 5.1: Setting up the external sidewalls

A flat plane with an incline of approx. 1 % in the direction of the front side was installed in this semi-enclosure. This incline was necessary to collect any precipitation in the forward area of the system and to suck it off via the PVC pipes installed there.

It was necessary to ensure that the gravel used for this purpose was free of larger stones or other contamination, so that the sheet to be installed in the following step was not damaged. Figure 5.2 shows the building of the plane prior to installing the sheet.



Fig. 5.2: The first layer of gravel is installed

To protect the ground water against contamination, an oil-resistant sheet was laid out on this flat and slightly inclined plane (see Fig. 5.3).



Fig. 5.3: Installing the oil-resistant sheet

Next, a 0.6 m thick layer of gravel was placed over the sheet and then compacted (Fig. 5.4).



Fig. 5.4: Applying the layer of gravel

After the gravel material had been introduced for the rear area, the still open forward side was closed with three layers of concrete slabs until a height of 0.6 m was reached. The sheet was folded up so that a closed tanking was formed. Now the drainage pipes could be placed and the remaining gravel for the forward area was introduced (see Fig. 5.5).



Fig 5.5: The tanking is closed; the remaining gravel is introduced via a ramp using a wheeled loader.

With this method of construction it was possible for the arising precipitation to drain off over the sheet, where it was then siphoned away via the drainage pipes so that it did not impair the stability of the "ground foundation".

Concrete slabs 3000 x 1000 x 200 were laid out on this gravel bed as a foundation for the fire troughs for the railway tank car and the CASTOR container (see Fig. 5.6).



Fig 5.6: Laying down the cover slabs

After the cover slabs had been laid out, the approx. 6 m high, surrounding U-shaped earth embankment was completed (see Fig. 5.7). The purpose of this earth embankment was to prevent parts of the railway tank car from being hurled into the surrounding forest area after a BLEVE and possibly causing fires.



Fig 5.7: Building the earth embankment for the fire stand.

The embankment was constructed by an engineering unit of the Federal Armed Forces using earth material from the site. Approx. 6000 m³ of soil had to be moved for this purpose.

After the rear part of the earth embankment had been completed, the fire trough for the railway tank car was constructed. For this purpose, a welding tent (see Fig 5.8) was set up on site on the cover slabs; protected against the weather by this tent, welding work was then continued to construct the 5 x 10 m fire trough for the railway tank car using 2.5 mm sheet steel.



Fig 5.8: The welding site for the fire trough for the RTC

The tanking was constructed to a height of 500 mm. The side panels were made double walled so that water-cooling could take place in these areas. Fig. 5.9 shows the completed tanking for the RTC shortly before the railway tank car was placed inside.



Fig 5.9: The fire trough for the railway tank car

The RTC was aligned centrally within the tanking and placed directly on the tanking floor, which had been reinforced with 20 mm sheet steel in the area of the wheel sets.

As can be seen in Fig. 5.9, the sequence in which the individual work steps were carried out was very significant. Thus, for example, in order to allow the crane adequate freedom of movement, the lateral parts of the embankment could only be completed after the RTC had been set up within the tanking.

5.1.2 Protected shelters for visitors

As it was not possible to accommodate all invited guests within the administrative building, it was necessary to find additional means of accommodation elsewhere. An obvious choice was to make use of the height of the grade tracts. From here both the visual and acoustic "experience" of the test and its effects would most likely be the best, although even here it would not be possible to do without camera images. Regular 20-foot containers, which had to be furnished accordingly, were used (see Fig. 5.10).



Fig 5.10: The observation containers on the grade tracts

Because the distance to the blast area was approx. 650 m, and the possibility of debris flying up to 800 m had to be reckoned with (see section 4.5), the containers had to be "armour-plated".

To accomplish this, 7 stacks of road construction slabs, each consisting of 8 layers, were stacked in front of the containers in the direction of the blast area. This "concrete wall" had a total weight of approx. 60 t, and the test management group considered this to be adequate protection. The roofs of the containers were reinforced with 8 mm thick steel plates. As these did not cover the entire roof area, additional wood palisades consisting of 8 to 10 cm thick pinewood were installed. The viewing slits were covered with splinter-proof polycarbonate glass.

5.1.3 Protection for camera sites

To provide adequate test documentation, it was necessary to set up camera locations positioned as close to the fire stand as possible. As a means of protection against flying debris and the expected blast wave, the earth embankment was opened at points and covered with wooden palisades (see Fig. 5.11).



Fig. 5.11: Camera at the earth embankment; distance to the fire stand approx. 200 m

5.2. Organizational measures

5.2.1 Outside of the test premises

Before the test was carried out, a detailed test program was devised to clarify both the individual activities taking place and the schedule for them. Safety zones were defined, which - during the progress of the test - were to be accessed only by those persons named in the test program.

Because – as described in section 4 – would have action radii of > 200 m, it was necessary to consult and collaborate with the munitions dissection operations of the state of Brandenburg, whose terrain borders directly along the test area, as well as with the municipal authorities of the Administrative district Teltow-Fläming. As the test ground is not fenced in and is therefore freely accessible, special attention had to be paid to sealing off the area and providing personnel supervision for all access driveways. Altogether there were 30 blockage points each manned by a double-guard.

As BAM is not in a position to provide such manpower, the external sealing-off was performed by employees of the munitions dissection operations and by the Federal Border Guard Command East, which performed this service in response to a request for cooperation. This also concerned the guarantee of communication along the property boundaries as well as central communication to the project management group on the grade tracts. Because of the action radii involved and the time at which the test was conducted (prevention of forest fires) technical and personnel support was requested from the State of Brandenburg (police, fire department) and the Federal Armed Forces (containers, communications, tank fire engine, heavy engineering apparatus, helicopter). It was only through this partnership that it became possible to ensure that the test could be carried out safely even at a time where there was a high risk of forest fire. The following table is an overview of all the personnel that contributed to providing protection for the test:

Institution/Office/Authority	Task	Number of the vehicles/persons
The promoting organization Horstwalde Traffic Testing Facility.	Securing buildings and terrain	1 Service vehicle/1 + 20
Munitions dissection operations of the state of Brandenburg	Securing buildings and terrain	3 Service vehicles/12
Police headquarters Potsdam, protection area Teltow-Fläming	Securing terrain, jurisdictional authority for the State of Brandenburg	1 Radio squad car/2
Fire department, district fire chief for the administrative district of Teltow-Fläming	Head of operations for fire departments	1 Police car/1
Administrative district Teltow-Fläming, offices of the municipal authorities	Technical head of operations	2 Service vehicles/5
Federal forestry office Neubrück	Specialist advice on forestry	1 Service vehicle/1
Fire department of the administrative district of Baruth	Forest fire prevention	1 Tank fire engine/3
Fire department of the administrative district of Gottow	Forest fire prevention	1 Tank fire engine/3
Fire department of the administrative district of Sperenberg	Forest fire prevention	1 Tank fire engine/3
Fire department of the administrative district of Jüterbog	Forest fire prevention	1 Tank fire engine/3
Fire department of the administrative district of Luckenwalde	Forest fire prevention	1 Tank fire engine/3
Fire department of the administrative district of Baruth	Forest fire prevention	1 Fire engine LF 8/8
Fire department of the administrative district of Merzdorf	Forest fire prevention	1 Fire engine LF 8/8
Fire department of the administrative district of Horstwalde	Providing water for fire-fighting	1 Fire engine TS 8/4
Federal Border Guard Command East	Securing terrain, enforcing domiciliary rights	6 Service vehicles/48
as above	Communications	1 mobile radio station/2
Fed. Armed Forces: Special Corps of Engineers 800	Forest fire prevention	2 Tank fire engines/6
Federal Armed Forces: Military District Command VII und 13. Armoured Infantry Division, Leipzig	Forest fire prevention	1 Tank fire engine/6
Federal Armed Forces: 1st transport battalion 143 Strausberg, telecommunications train	Communications: bunker → grade tracts	4 Service vehicles/20
Federal Armed Forces: Army liaison and reconnaissance flying squadron 400, Cottbus	Forest fire observation	1 Helicopter Bo 105/2
as above	as above	VW - Transporter, mobile radio station/2
Federal Armed Forces: Engineers Brigade 80, Storkow	Forest fire prevention/ cutting breaks	Sapper tank "Dachs"/3 semitrailers/4
Summary:	10 Tank fire engines	45
	1 Sapper tank	7
	1 Helicopter	2
	2 Mobile radio stations	4
	1 Radio squad car	2
	18 Service and police vehicles	108
		168 persons

Table 4: Personnel and technical effort for providing technical safety and protection during BAM's large-scale test project on the test grounds at Horstwalde

Because the acoustic and visual consequences of this test would extend beyond the boundaries of the test ground, during the preparatory phase the responsible district government offices and representatives of the neighbouring municipalities and the press were also included. The populations of the neighbouring municipalities were informed of the intended test by means of a corresponding communication in the Official Bulletin. In retrospect it can be said that this open information policy proved itself and contributed to a broader acceptance of the test ground.

Further to the above, the following authorities and offices were advised about the test:

- District administration Teltow-Fläming, offices of the municipal authorities, Luckenwalde
- Ministry for nutrition, agriculture and forests, Forestry Dept., Potsdam
- Ministry for environment, nature conservancy and environmental planning, Dept. for nature conservancy and landscape management, Potsdam
- Ministry for nutrition, agriculture and forests, Dept. 53, Potsdam
- Ministry of the Interior, Brandenburg, Dept. III/4, Potsdam
- State munitions salvage service of the State of Brandenburg, Waldstadt/Gem. Wünsdorf
- German air traffic control GmbH, regional office Berlin-Tempelhof
- Brandenburg state administrative office for traffic and road construction, BLVS, Department 24, Aviation, Dahwitz-Hoppegarten
- Police headquarters Potsdam, protection area Teltow-Fläming, Jüterbog
- Federal forestry office Neubrück
- Baruth government office, Baruth
- Am Mellensee government office, Sperenberg
- Horstwalde forest wardens office, Baruth
- Luckenwalde government office for forestry, Sperenberg senior forestry office

5.2.2 Within the test premises

Areas that were considered particularly sensitive were the drop tower (see Fig. 3.1), the administrative building (Fig. 3.2), the fire lookout tower (Fig. 3.3) and the lightweight construction sheds (Fig. 3.4).

All gates, doors and windows of the light-construction sheds were opened and locked in an open position to allow the passage of the blast wave.

Within the entire complex, damage-susceptible arrangements were placed at ground level and combustible fluids were removed.

Some of the visitors and technical helpers were accommodated on the ground floor of the administrative building. Here too, all doors and windows were opened. Every person present received an ear-protector cap.

The door and windows of the fire observation tower were also opened. During the test this tower also served as a camera site. During the test the fire observation tower was unoccupied. Due to the method of construction used, the fire tower is less prone to damage by a blast wave. Only damage due to flying debris was conceivable. Due to the low probability of a direct hit, no special precautions were taken.

During the test, those persons immediately engaged in the test work remained in the ground bunker at the end of the "swallowtail", where the measuring equipment was also installed. The distance to the fire stand was about 500 m. The alert rooms for the tank fire engines were located beyond the 1000 m safety area. Any person who had to remain within this area was assigned protective accommodation (containers on grade tracts, administrative building).

6. Summary of the test results /10/

6.1 Test rig

The April 27, 1999 fire test conducted at the test grounds in Horstwalde (see section 3) using a railway tank car for liquefied gases, served as a means for determining the failure limits and effects of undergrate firing on a railway tank car.

For this purpose a railway tank car having a nominal capacity of 45,360 l, a test pressure of 28 bar, made of fine-grained structural steel BH 42 K and containing approx. 10 m³ (= 5.1 t) of liquid gas (commercially available propane in compliance with DIN 51622) - which corresponds to approx. 22 % filler content - was subjected to the effects of a burning pool of fuel oil.

For further details on the dimensions of the railway tank car as well as the material characteristics, please refer to the test report /10/ enclosed. Due to the fact that in such a test extreme temperature and pressure loads as well as mechanical effects resulting from the explosion can be expected if the railway tank vehicle fails as a result of the high temperature, the opportunity was used to position next to the railway tank car a THTR/AVR Castor - a previously unused container for radioactive material - to also subject it to the effects of the fire.

Both test objects, the railway tank car and the unloaded Castor container were put into two separate fire troughs, which stood on a flat slab foundation (15 x 15 m) that was surrounded by a U-shaped sand embankment (60 x 50 x 6 m). The fire troughs were filled with fuel oil to feed the fire for approx. 40 minutes.

The sand embankment surrounding the test stand served to smother the possible and/or expected consequences (flying debris, blast wave) and/or to guide them in a preferred direction as far as possible.

In the event that the railway tank car did not fail during the fire, a relief facility was provided with which it would be possible to release the pressure in the tank so that its liquid gas content could be burned off. 10 thermocouples were used to measure the temperature of the fire and 11 were used to measure the temperature of the tank.

During the entire course of the test, the interior pressure was measured with 3 pressure sensors and the interior temperature with 4 thermocouples; this data was recorded (see test report /10/. Similarly, 3 pressure sensors served to determine the ambient pressure when the tank failed, 3 thermo indicator strips were provided to determine the heat load of the fireball and two further sensors served to determine the heat flow of the fireball.

6.2 Photographic and cinematic documentation; observation sites

The test was video-documented from four different ground positions and from a helicopter.

Additionally, photographs were made from a further helicopter.

The guests attending on the day of the test were accommodated in 3 protected 20 foot containers located approx. 650 m away, as well as in a building complex located approx. 600 m away. The test team was housed in a bunker located approx. 500 m away; this bunker also contained the measuring equipment (see test report and section 3). As no direct view of the test process was possible from the secured observation sites, video images were transmitted to display monitors at all these points, so that the test process could be followed.

6.3 Test method

After the three ignition devices had been ignited in each fire trough, the fire built up within 100 seconds and heated up the railway tank car and the Castor container. Because a light (2 m/s) wind prevailed mainly from a northerly direction during the entire test, the fire did not completely

enclose the railway tank car; rather, the container was mainly heated up at the rear. The first increase in pressure was recorded after approx. 130 seconds; during the next 15 minutes the pressure rose continuously to 25 bar; then the tank burst. The corresponding wall temperatures in the failure area were approx. 550 °C; the fire temperatures in these areas were on the average between 750 °C and 1000 °C (see test report). Because altogether there were only 11 temperature measuring points on the container wall, it was not possible to be sure to record the point having the highest temperature. However, it can be assumed that, because of the good agreement between the fire temperature and the wall temperature, the area in the proximity of the tank equator must have been the area with the highest temperature. From this it can be deduced that the temperature at this point cannot have been lower than the highest temperature actually measured.

At the other measurement points, there were temperatures ranging between 135° C (vertex on the right) and approx. 400° C. Correspondingly, the wall temperatures found here were lower, i.e. between approx. 100° C (the area around the fittings) and approx. 380° C. On the one hand, the reason for the temperature distribution of the fire could have been the prevailing wind conditions, and on the other hand it could also have been the rear embankment tunnel, which had been provided to install the relief line; this tunnel may have contributed to a better air supply.

The heat input caused by the fire resulted from the higher heat capacity, mainly in the liquid state. The mean temperature rise of the liquid state was approx. 4.48 K/min. As last highest temperature determined was 68.8 °C. This temperature is the decisive factor governing the pressure in the tank. The mean rate of pressure increase was approx. 1.33 bar/min.

Due to the failure in the rear equator area (for a precise description, please refer to the test report), the tank folded apart in the same way upwards and downwards. This caused the liquid gas to be released; the released gas expanded and propelled the container and the chassis forwards in the direction of the Castor container. After the test, the chassis was found wrapped around the rack of the Castor, which had been shifted approx. 0.5 m by the impact. The jacket of the compressed-gas container collided against the forward lower part of the Castor cover and accelerated the latter so violently that it fell from its 1.15 m high rack, overturned and came to rest approx. 7 m away. In doing so it dug itself into the ground.

Smaller debris (e.g. the distribution cable, label plates) was found approx. 60 m away.

As a result of the compressed-gas container bursting, starting from the back, the cylinder bottoms were ripped away from the cylindrical part and then propelled forwards. While the tank was ripping open, a triangular segment became detached from the left rear part of the jacket. While the jacket was being unravelled, the baffle plate inside the container was hurled up to a height of approx. 200 m and was later found approx. 145 m away. Overall, the container became separated into 4 larger parts, the left bottom (with manhole), the right bottom, a larger - partly folded - section of the jacket, as well as a smaller section of the jacket, which dug itself vertically into the ground. After the test, the left tank bottom, the right tank bottom, the larger part of the jacket and the smaller part of the jacket were respectively found approx. 130 m, 155 m, 150 m and 200 m away from the test stand.

With the overall weight of the railway tank car being 17,890 kg (chassis and axes = 7,960 kg and compressed-gas container = 9,930 kg) the following masses can be calculated for the individual sections of debris:

Left bottom (with manhole)	1400 kg (weighed)
Right bottom	~ 1200 kg (estimated)
Larger part of jacket	~ 6710 kg (estimated)
Smaller part of jacket	~ 350 kg (estimated)
Baffle plate with reinforcements	~ 210 kg (estimated)

The fireball that appeared while the compressed-gas cylinder was bursting had a maximum diameter of approx. 100 m and a height of approx. 150 m; it lasted approx. 7.2 seconds.

The ambient pressure recorders that had been set up at 100 m, 150 m and 200 m registered

peak values of > 0.02 bar; however these values most probably do not represent the real existing conditions because the steep drop in the curves suggests that the recording process was either affected by the flying debris or by the temperature sensitivity of the pressure sensors (thermoelectric effect).

The heat flow caused by the fireball was roughly estimated as > 80 kW/m², because it cannot be assumed that the entire opening angle of the sensors had been filled out by the fireball.

6.4 Short overview of the most essential test data

Railway tank car:

Nominal volume	45360 l
Test pressure	28 bar
RID requirements for design pressure and test pressure	27 bar (for propane)
Filler content	approx. 22 % ($\cong 5.1$ t)
Total weight	17890 kg

Summary of the test results:

Duration of fire	15 min (fuel oil)
Failure pressure	25 bar
Minimum jacket temperature (fittings area)	100 °C
Maximum jacket temperature	approx. 550 °C
Fire temperature	750 °C - 1000 °C
Temperature of the liquid state	approx. 68.8 °C
Diameter of fireball	approx. 100 m
Height of fireball	approx. 150 m
Duration of burning of the fireball	approx. 7.2 s
Heat flow of the fireball	> 80 kW/m ²

Flight distances and masses of the debris:

Left bottom (with manhole)	approx. 130 m	approx. 1400 kg
Right bottom	approx. 155 m	approx. 1200 kg
Larger part of jacket	approx. 150 m	approx. 6710 kg
Smaller part of the jacket	approx. 200 m	approx. 350 kg
Baffle plate with reinforcements	approx. 145 m	approx. 210 kg

As already mentioned at the beginning of this section, further, more in-depth information can be found in the attached Test Report No.III.2/9907 dated 30.06.1999.

7. Conclusions

The test conducted here has shown that a railway tank car partially filled with 5.1 t of propane and subjected to undergrate firing can fail within 15 minutes at less than the 28 bar test pressure, even if the fire does not fully envelop the container.

The fireball - resulting from a bursting container in which the released propane evaporates instantly and then ignites (BLEVE) - which had a diameter of approx. 100 m as well as the distance that some of the debris flew (up to 200 m) indicate that a fire situation will in a relatively short time cause a serious danger that should certainly be countered by applying and providing suitable safety-engineering measures.

Due to the very short time periods available in such situations, wanting to provide fire-protection for railway-tank car transfer stations primarily and/or even just secondarily by means of the fire brigade must be considered as rather unsuitable, because it must be assumed that - in the short time available after the fire brigade has arrived - the fire brigade will not be able to provide suitable measures to protect the container(s) against a BLEVE.

Furthermore, the test leads to the conclusion that containers having a higher test pressure and a greater steel-wall thickness than equally large storage containers do not necessarily reveal higher safety reserves in a fire situation. It was possible to confirm experimentally that, in such a fire situation - which incidentally must be assumed when adequate safety measures are being designed for storage containers - even for large containers the decisive factor leading to tank failure is heat to the container wall in the area of the gaseous phase in conjunction with the increase in internal pressure brought about by the input of heat.

Because an earth embankment trilaterally surrounded the test stand and there was a specific wind direction during the test, the fire developed in such a way that primarily that side of the tank car facing away from the embankment opening was heated and thus got hottest. When the container was torn open in this area, the container and the chassis were propelled in the direction of the Castor container and abruptly decelerated on impact with it. This circumstance can explain why the container fragments flew in a preferred direction, whereby some of these parts (larger jacket part and right bottom) had multiple ground contacts.

During the impact of the tank car against the Castor container, a large part of the kinetic energy was transferred to the Castor so that it cannot be excluded that, with "unobstructed" movement, debris could fly even further than what happened in this test, whereby it is not possible to quantify such distances because a large part of the energy was used up in deforming the debris, particularly the chassis of the tank car.

Although it is theoretically possible to calculate the velocity of the Castor from the flight distance, the measurement results and the video recordings do not facilitate determining the exact time up to which acceleration took place.

The results of the formula recommended by the International Labour Office (ILO) (see section 4) for calculating the diameter and the duration of the fireball agree very well with the values determined in this test.

To sum up the results of this test, it can be said that - at least as far as fire situations are concerned - railway tank cars in LPG transfer stations should be safety-engineered to the same requirements as storage containers set up stationary.

When setting up and operating such transfer stations, it is increasingly necessary to take into account the influence of such danger sources in the environment that could cause a heat load. According to the present state of knowledge, only thin-film fire insulation provided as a passive measure or an adequately dimensioned water sprinkler facility (incl. additional safety engineering measures such as gas warning and fire reporting systems, automatic triggering, building measures) can be considered because, when a fire breaks out, the remaining time may be too short for the fire brigade to provide the necessary cooling measures.

Furthermore it would be possible to equip compressed-gas railway tank cars with adequately dimensioned safety valves. On the one hand these can contribute to delay the pressure build-up during a fire condition while, on the other hand, it is a known effect that blowing off pressure via safety valves has a cooling effect which can also reduce the speed at which the tank walls are heated.

BAM considers the cost of insulating railway tank cars to be very high. It is thus very probable that in future water sprinkler systems will be the preferred choice - in spite of the disadvantage offered by active fire-protection measures.

It is before this background that a further complex of questions arises; it is urgent that these questions be answered, and they must be answered within the context of revised laws and rules both for new facilities as well as for retrofitting existing plants.

1. Can current sprinkler concepts for RTC transfer stations prevent sudden container failure resulting from a fire condition? As the experiment shows, container failure may also occur if,

because of the existing wind, the flames only reach certain areas of the container walls.

What risks are there with regard to the currently preferred organizational measures for incorporating the fire departments in these concepts? Can fire departments reliably prevent container failure with the means at their disposal?

2. What are the framework conditions (choice of location, environment-induced fire loads, shielding buildings), under which the risk of container failure can be assessed as being so low that fire-protective measures can be completely done without or conducted on the basis of a scaled-down concept (e.g. partial sprinkling)? In this case, what role should the fire department play? Under the aspect of disaster control, is it at all conceivable or safe to operate a transfer station without fire-protective measures?
3. Is it possible to accept that an (unprotected) road tank vehicle may stay in a transfer station for a limited length of time? How high is the risk of damage escalation in this case? After clarifying the aforementioned questions, is it necessary to also incorporate road tank vehicles into a sprinkler concept?

The fire test impressively revealed to all participants that heat loads might cause even thick-walled railway tank cars to fail with disastrous consequences. During preparatory work for the test, participants frequently expressed the opinion that, because of the mass of steel and the fillage level involved, this would not be possible; this opinion cannot be confirmed. These facts show that there is need for further research in the sense of the above complex of questions.

8. References

- /1/ DIN 51622 Flüssiggase: Propan, Propen, Butan, Buten und deren Gemische, Anforderungen, December, 1985
- /2/ Bundes-Immissionsschutzgesetz (BImSchG): Bekanntmachung der Neufassung des Bundes-Immissionsschutzgesetzes dated 14 May, 1990 (BGBl. I S. 880), revised by law on 22 April, 1993 (BGBl. I S. 466) (last)
- /3/ Zwölfte Verordnung zur Durchführung des Bundes-Immissionsschutzgesetzes (Störfall-Verordnung - 12. BImSchV) in the version of the announcement dated 19 May, 1988 (BGBl. I S. 625)
- /4/ Sicherheitstechnische Anforderungen an Flüssiggasanlagen Gem. RdErlaß des MS u.d. MU v. 06.07.1995 - MS 504-40221/04/MU 303-40501/209.1.2.-Voris
81 640 00 00 00 004
- /5/ Uelpenich, G.: Freisetzung druckverflüssigter Gase: Gefährdungsabschätzungen; Brandschutz/Deutsche Feuerwehr-Zeitung 10/1993, p. 696 - 702
- /6/ Bussenius, S.: Abschätzung von Schadenfolgen als Grundlage für die Festlegung von Schutzmaßnahmen, Schadenprisma 4/92, S. 64 - 68
- /7/ BAM Tests 1.5/399 and 1.5/400, Lehre 1983, personal report by Dipl.-Ing. M. Mallon
- /8/ Collins, G.-R.: Einsatzbericht über das Brandereignis dated 16 May, 1986 in Stockton/California, translated by: Freie und Hansestadt Hamburg, Behörde für Inneres, Feuerwehr
- /9/ Leiber, C.-O.: Explosionen und Detonationen - Stoffe, Ereignisse, Mechanismen, Risiken; Swisttal, November 1995
- /10/ Test report III.2/9907: Brandversuch mit einem Propankesselwagen, Federal Institute of Material Research and Testing, Süpecialist group III.2, Berlin, 30.06.1999

Appendix

Test Report III.2/9907

Fire test with a propane tank car

Contract awarded by: Saxon Ministry of State for Environment and Agriculture

Ostra-Alle 23

01067 Dresden

represented by the:

Saxon Administrative Office for Environment and

Geology

Zur Wetterwarte 11

01109 Dresden

Performed by: Federal Institute of Material Research and Testing
(BAM)

Specialist Group III.2; Dangerous-goods tanks and
accident mechanics

12200 Berlin

Test number: III.2/9907

Test object: Propane tank car with nominal capacity of 45 m³, test pressure 28 bar

Test site: Test grounds of BAM in Horstwalde

Test date: 27.04.1999

Federal Institute of Material Research and Testing (BAM)

12200 Berlin, Unter den Eichen 87, 99-06-30

Specialist Group III.2

Laboratory III.21

Dangerous-goods tanks and accident mechanics

Tank safety; Mechanical and thermal tests

p.p

p.p

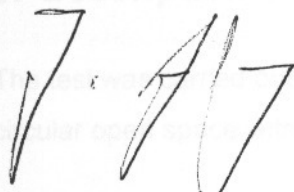

Dipl.-Ing. J. Ludwig



Dipl.-Ing. W. Heller

1. Problem definition

A study awarded and partly financed by the Saxon Ministry of State for Environment and Agriculture was designed to investigate the effects that an accident fire would have on a partly filled railway tank car for liquefied petroleum gas (propane), and what consequences a bursting of the tank due to the temperature and pressure load would have for the environment.

2. Test object

The test object consisted of a tank car for liquefied gases with a nominal volume of 45360 l, a test pressure of 28 bar and made of fine-grained structural steel.

The standard values for this material are:

Yield point $R_e = 420 \text{ N / mm}^2$

Tensile strength $R_m = 550 \dots 660 \text{ N / mm}^2$

Wall thicknesses (according to drawing): 14.5 mm (cylinder) and 16.0 mm (bottoms)

Wall thicknesses (measured, see encl.): 14.9 mm (cylinder) and 17.0 mm (bottoms)

Length (along the bottoms): 7600 mm

Length (cylinder): 5950 mm

Diameter: 2900 mm

The last recurring test was performed by TÜV Hannover/Saxony on 27.11.1998. On arrival, the railway tank car was empty and had been cleaned.

Due to the fact that BAM is also responsible for the mechanical and thermal approval tests and, furthermore, that in such a test extreme temperature and pressure loads as well as mechanical effects resulting from the explosion can be expected if the railway tank vehicle fails as a result of the high temperature, the opportunity was used to position next to the railway tank car a THTR/AVR Castor - a previously unused container for radioactive material - to also subject it to the effects of the fire.

3. Description of test setup

The test was carried out on the BAM test grounds in Horstwalde. On these grounds there is a circular open space with a radius of 200 m (see Fig. 1).

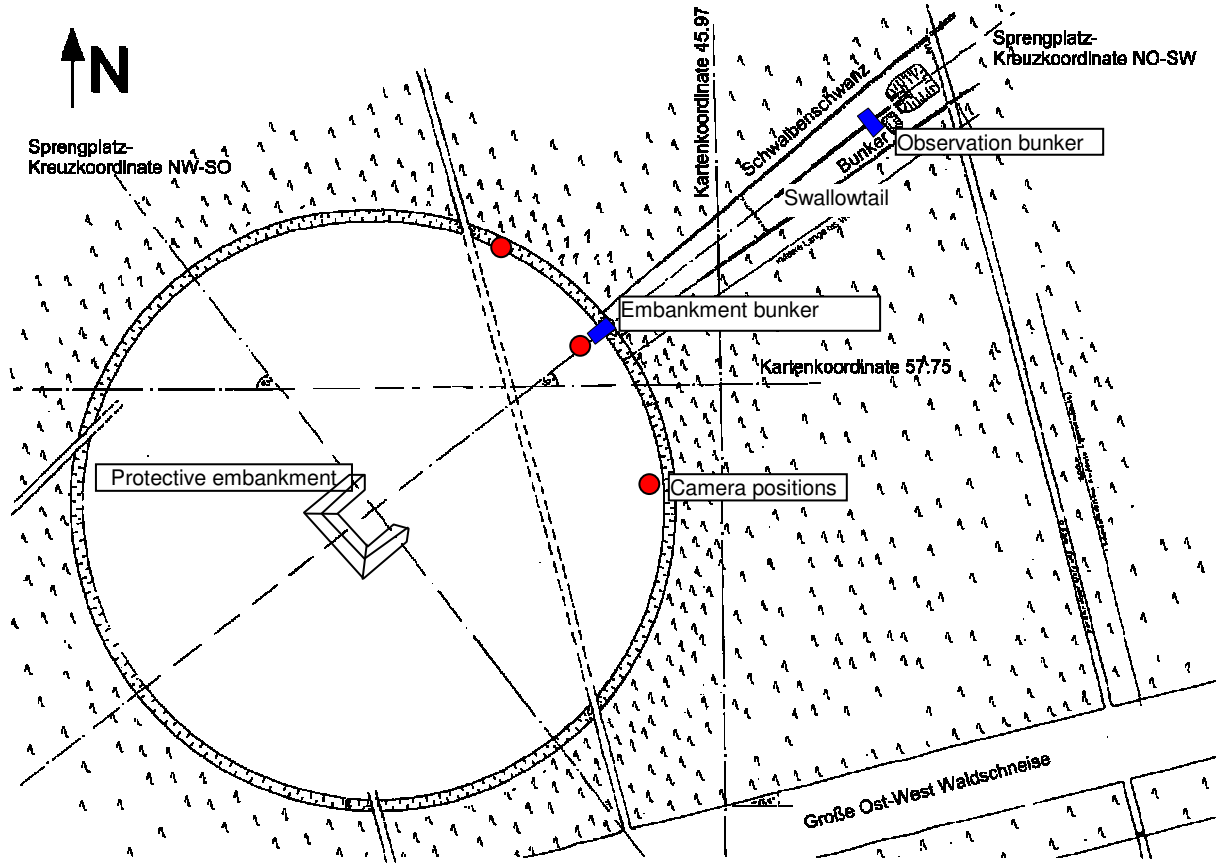

Fig. 1: Test grounds with open area

Located approximately in the centre of this open space, there was a U-shaped protective embankment approx. 42 x 55 m in extent and 6 m high; it served primarily to restrict the blast wave and the flight of debris.

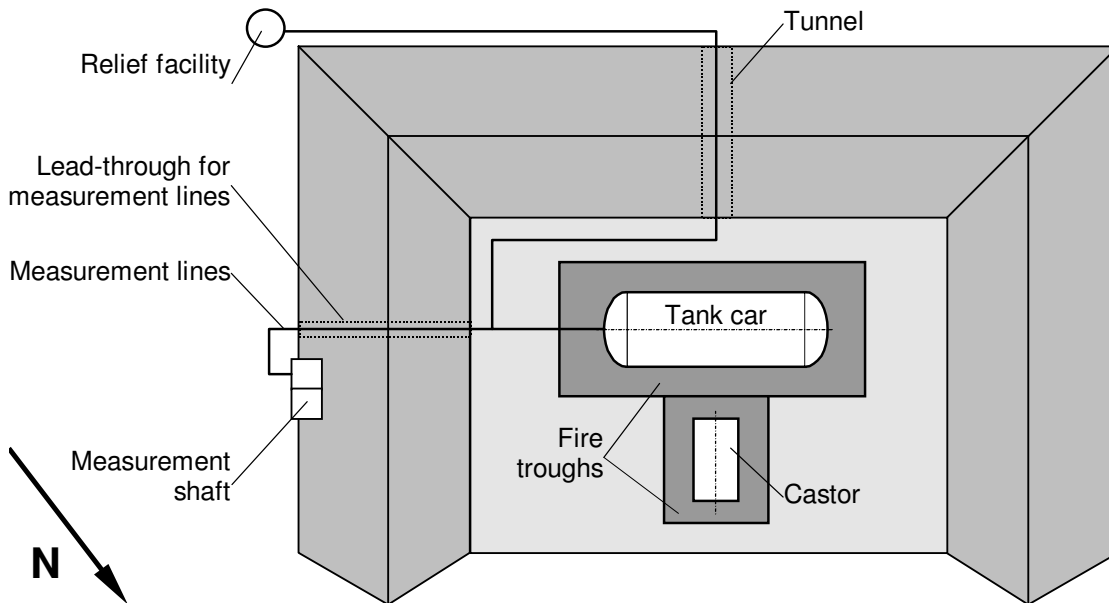

Fig. 2: Protective embankment with fire troughs

Within this embankment there was a 10 m x 5 m x 0.5 m fire trough for the tank car and a 5 m x 3.5 m x 0.5 m tank car for the CASTOR container.

During the experiment, the front-sided cover of the Castor was turned towards the tank car. The inspection opening of the tank car pointed to the left.

All directional details in this report refer to the direction of view as seen from the observation bunker in Fig. 2.

Fig. 3 shows the test setup during instrumentation.



Fig. 3: Test stand within the protective embankment

4. Instrumentation and measuring chain

As the rising temperature is a decisive factor affecting both the internal pressure as well as the drop in strength of the tank walls, a relatively large number of temperature-measurement points (type K jacketed thermocouple, by Heraeus) were provided. Fig. 4 shows the measurement points provided on the tank car and the Castor. The 10 measurement points provided for the fire temperature, which were primarily installed in the upper half of the tank, served to determine the degree with which the tank was enveloped by the fire.

With help of the 11 wall temperatures in conjunction with the 3 internal pressure sensors (P8AP 100 bar by HBM), it was possible to determine the drop in wall strength so that the point of bursting could be estimated. Using the 4 internal temperatures it was possible to determine whether and how much liquid state had already vaporized at the respective time (temperature difference between liquid phase and gaseous phase).

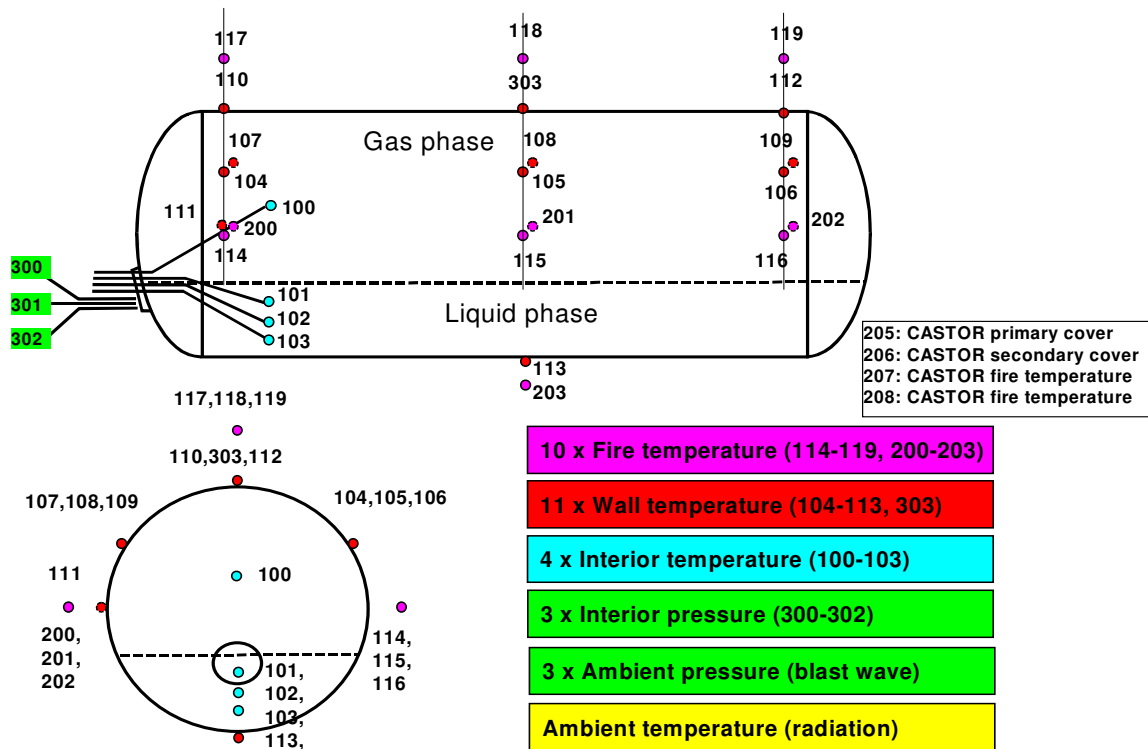

Fig. 4: Measurement points for instrumenting the tank car and the CASTOR

To lead out the internal measurement points, the cover of the inspection opening was provided with a centrally positioned reinforcement plate into which lead-throughs for the thermocouples and threaded connections for the pressure lines were screw-fastened (see Fig. 5).

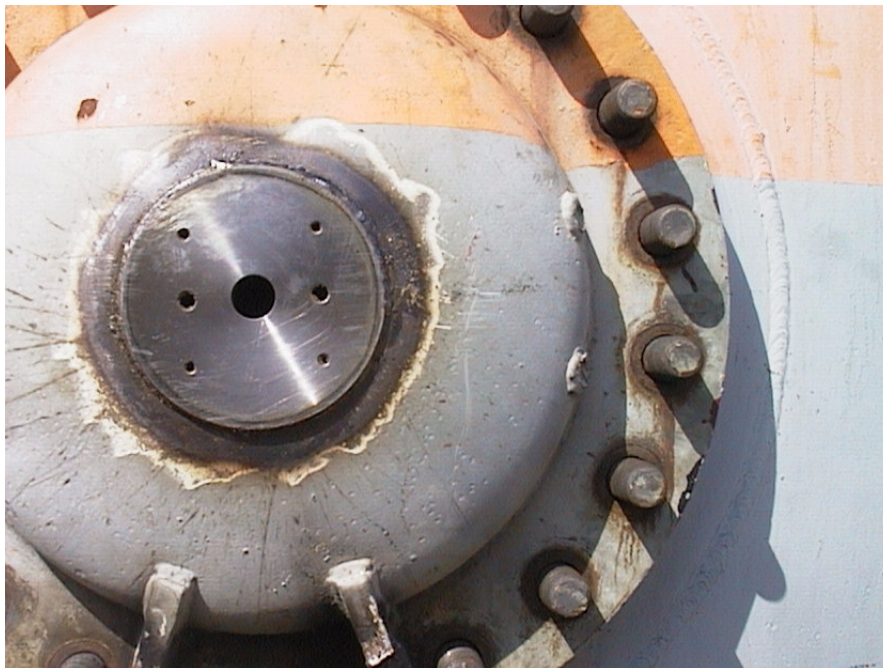

Fig. 5: Reinforcement plate in the cover of the inspection opening

In the event that the tank car did not fail while the fuel oil was burning, a relief facility was provided with which it would be possible to release the pressure in the tank so that its propane content could be burned off.

This relief facility, which could be remotely operated via cables (see Fig. 6) and which was located outside of the protective embankment, consisted of a ring nozzle as well as 3 propane burners installed above it and fed from one cylinder; the propane burners were equipped with a permanent ignition facility. The connection to the fuel tank was provided by a relief line (NW 18), which ended in the bottom of the tank, from where it passed centrally out of the reinforcement plate (Fig. 5) into which it was welded.



Fig. 6: Relief facility outside the protective embankment

The relief line, bundled together with the thermocouples for measuring internal temperature as well as the pressure-measurement lines, was led outside of the fire trough, downwards and then underground and/or thermally insulated to the relief facility. The pipe material used consisted of seamless pipes with a rated pressure of 450 bar as well as the necessary threaded connections. In the entire fire zone, all the pressure lines were thermally insulated with rock wool and an additional sheet-metal covering.

At the foot of the relief facility, in front of the ball valve (shown here without a lever) there was one of the three pressure recorders used for measuring and recording pressure. The remaining 3 pressure-measurement lines could also be turned off by one ball valve each in the proximity of the fire trough.

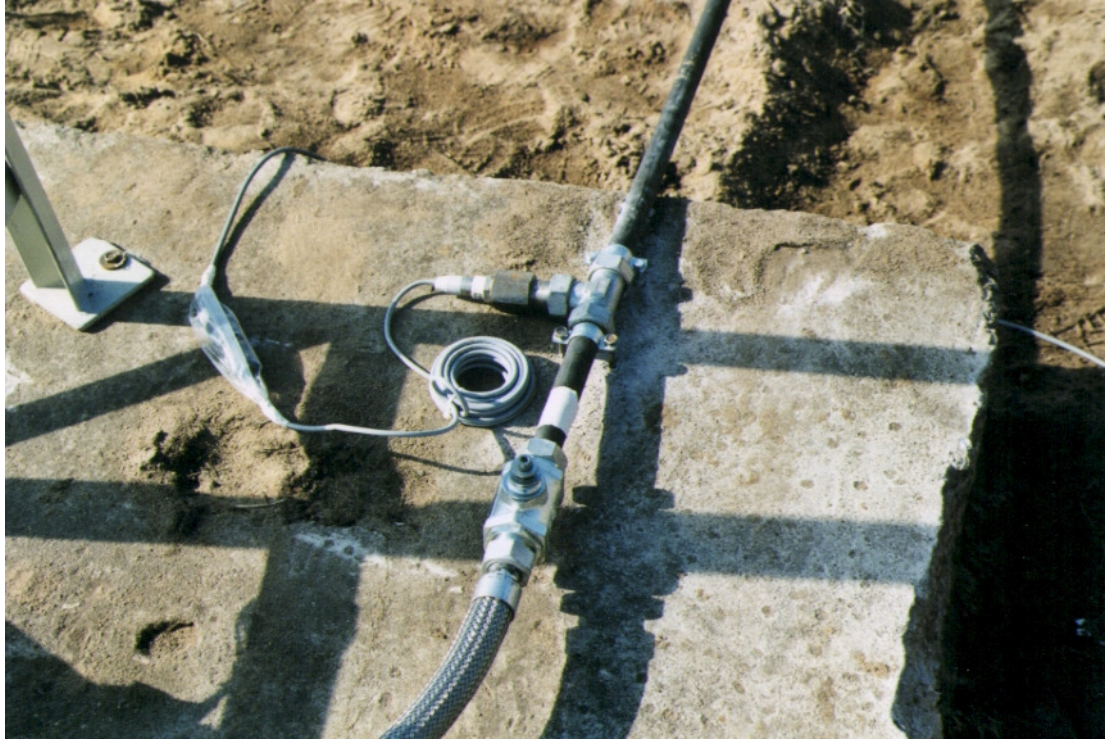

Fig. 7: Pressure recorder and ball valve (without actuating lever) in the relief line

Three sensors of the type PCB 137A23 were used to measure the ambient pressure; these were set up radially at distances of 100, 150 and 200 m from the tank car in the direction of the observation bunker.

The output signal of the ambient pressure sensors was sent via a model 442A02 ICP-sensor signal conditioner to an HIOKI 8832 digital recorder located in the embankment bunker (see Fig. 1).

Two sensors of the type Medtherm 64 were used to determine the heat flux of the fireball; these were located immediately at the foot of the embankment and their openings were aligned upwards.

Outside of the protective embankment, Reatec thermo-indicator strips were set up in four directions at two different distances from the centre of the fire trough of the tank car; these served to measure the temperature load resulting from the heat effect of the fireball. The measurement ranges were 128 to 188 °C and 193 to 254°C at a distance of 30 m as well as 82 to 135 °C and 138 to 188 °C at a distance of 50 m.

The recorded pressure, temperature and thermal flux signals were transmitted to an HP 3852A data acquisition system that had been installed in the measurement shaft (see Fig. 2), where they were digitised and stored in a computer; at the same time they were also transmitted via the light-conducting fibres of a network to a second computer located approx. 500 m away in the observation bunker (see Fig. 1). The analog pressure signals were also recorded on a Racal V-Store 24 magnetic tape device.

Furthermore, an HBM Digibar pressure indicator in conjunction with a digital display in the observation bunker were used - both operating completely independent - so that, in the event of a power failure during the test, information on the internal pressure of the tank would still be available.

5. Test method

The tank car was filled with 10 m³ of propane. This corresponds to a filler content of approx. 22 %.

Both fire troughs were filled with water to a height of approx. 30 cm, and then approx. 15 cm of fuel oil were added. In previous tests a mean burn-off rate of 3.5 to 4.0 mm/min had been determined, so that with this amount of fuel oil the fire would burn approx. 40 min. However, the precise burn-off rate is dependent on the pool size and wind conditions, which are decisive factors governing the amount of oxygen available for burning, so that it cannot be determined exactly beforehand.

Three independently electrically triggerable ignition devices were installed for igniting the fuel oil in each fire trough. These each consisted of a plastic bowl filled with petrol and placed on a wire frame mounted 30 cm above the surface of the fuel oil. Located in each bowl was an ignition device wrapped in cloth and providing an ignition energy of about 70 joules. The test was video-documented from four different ground positions and from a helicopter. Photographs were made from an additional helicopter.

After the shelters had been occupied and the helicopters and the cameras had started, the individual ignition devices were triggered one after the other from the observation bunker, starting at time 0 (Fig. 8).

The plastic bowls were destroyed after about 100 seconds so that the burning gasoline poured out on to the fuel oil which then ignited. After a relatively short time the troughs were burning completely.



Fig. 8: Triggering the ignition devices



Fig. 9: Flame appearance at the beginning of the test

The first pressure build-up in the fuel tank was recorded after approx. 130 seconds. For most of the duration of the fire, the fuel tank was only partly enveloped by the flames. Due to the predominant wind conditions (light wind from the north at 2 m/s) the best flame envelopment was seen in the rear left area.

As the test progressed, the wind decreased.



Fig. 10: Improved flame envelopment towards the end of the test

During the further course of the test, the pressure increased continuously for a period of 15 minutes to 25 bar; then the tank burst. The fuel tank tore open at the rear; the liquid gas that was released evaporated and burned off in a fireball having a maximum diameter of approx. 100 m and a height of approx. 150 m.

The following sequence shows the fireball from a distance of approx. 750 m. The photographs are spaced 0.4 seconds apart. From this sequence, the duration of the fireball is calculated to be 7.2 seconds.

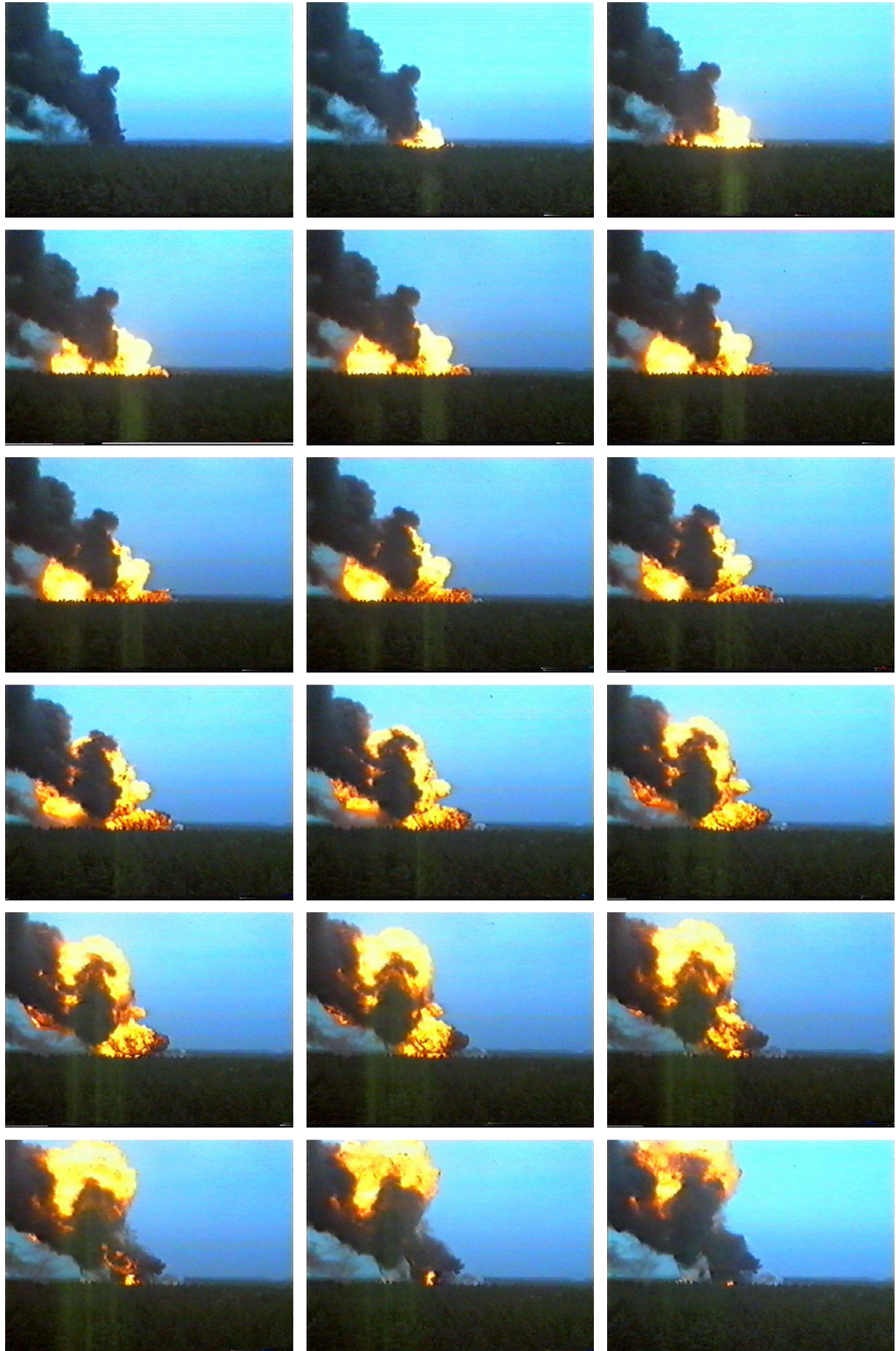

Due to the sudden release of liquefied gas and its resulting expansion, the tank jacket was unravelled and accelerated forwards. Starting from the back, the cylinder bottoms were ripped away from the cylindrical part and thus also propelled forwards. While ripping open, a triangular part (part 1 in Fig. 11) became detached from the left rear part of the jacket.

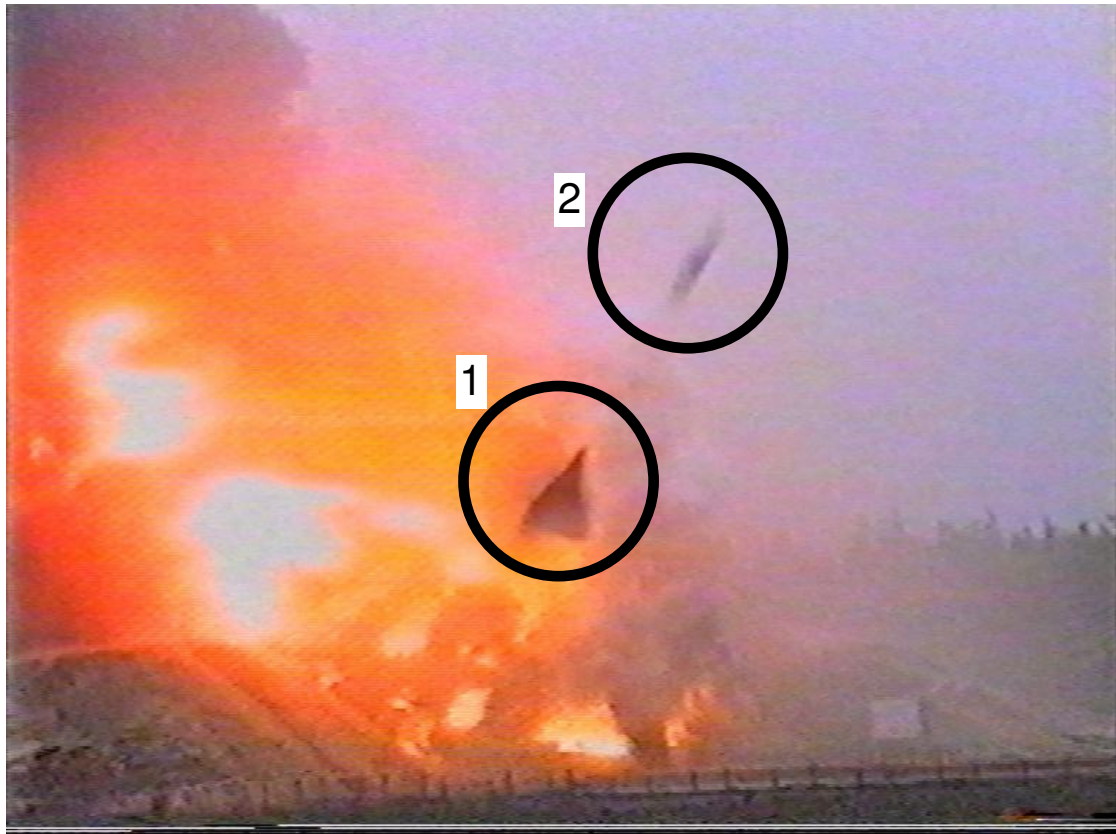

Fig. 11: Part of the jacket (1) and the baffle plate (2) flying off (left camera position (0.32 seconds))

Apparently the baffle plate (part 2 in Fig. 11) initially separated from the forward part of the jacket and then, due to a whiplash effect caused by the unravelling of the jacket, it was hurled up to a height of approx. 200 m (see Fig. 12).



Fig. 12: Baffle plate at highest point after approx. 4.6 seconds

Fig. 13 shows the fireball in its maximum extension



Fig. 13: Fireball seen from a north-easterly direction

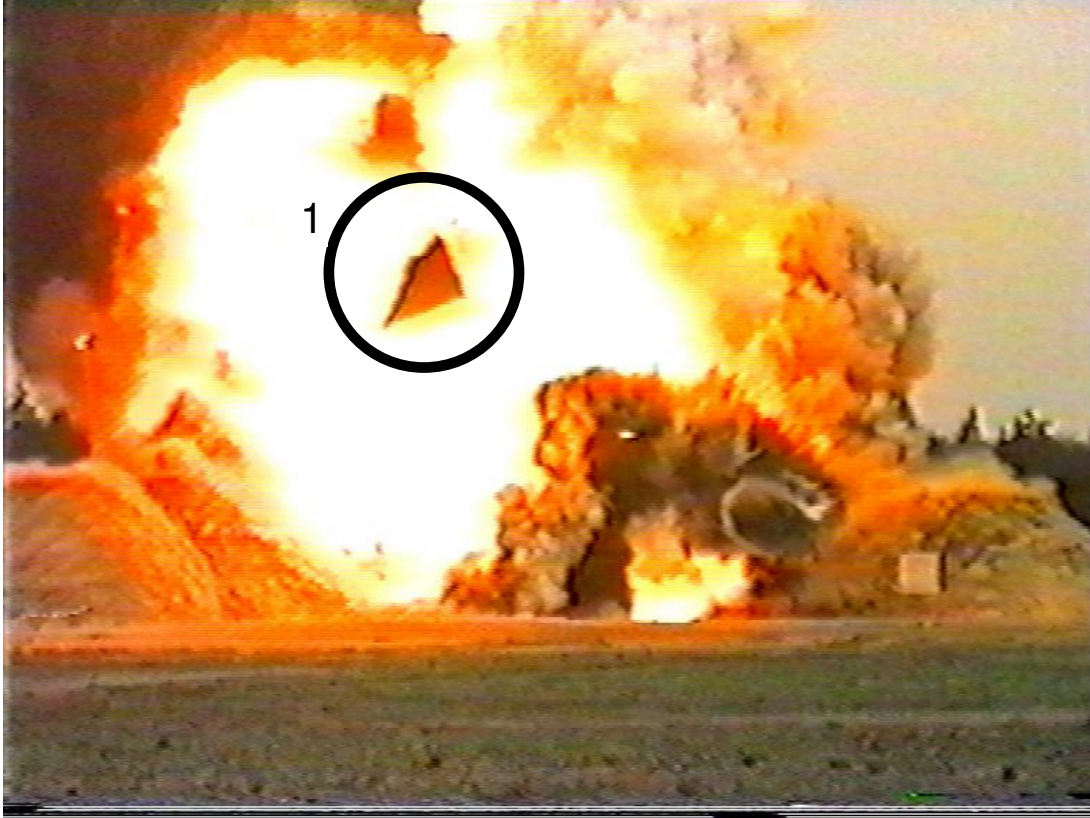

Fig. 14: Part of the tank jacket (1) flying off (central camera position)

In Fig. 14 it can be seen that the ignition of the released propane mainly occurred in the rear on the left side. Unburned propane is still discernible on the right part at this time.

The jacket collided against the forward lower part of the Castor cover and accelerated the latter so violently that it fell from its 1.15 m high rack, overturned and came to rest approx. 7 m away.

The jacket section (3) repeatedly struck the ground and came to rest in a partially folded state approx. 150 m away. The right bottom (4) was found approx. 155 m away (see Fig. 15).



Fig. 15: Jacket (3) and right bottom (4)

Der linke Boden (5) befand sich nach dem Versuch ca. 130 m vom Zentrum des Versuchsplatzes entfernt.



Fig. 16: Left bottom (5)

The jacket section (1) was found vertically slammed into the embankment surrounding the test grounds, approximately 200 m away from the latter.



Fig. 17: Position of the jacket section (1) after the test

The baffle plate (2) was found a distance of approx. 145 m from the test grounds.



Fig. 18: Baffle plate (2)

Figure 19 provides an overview of the positions of the different tank parts and debris:

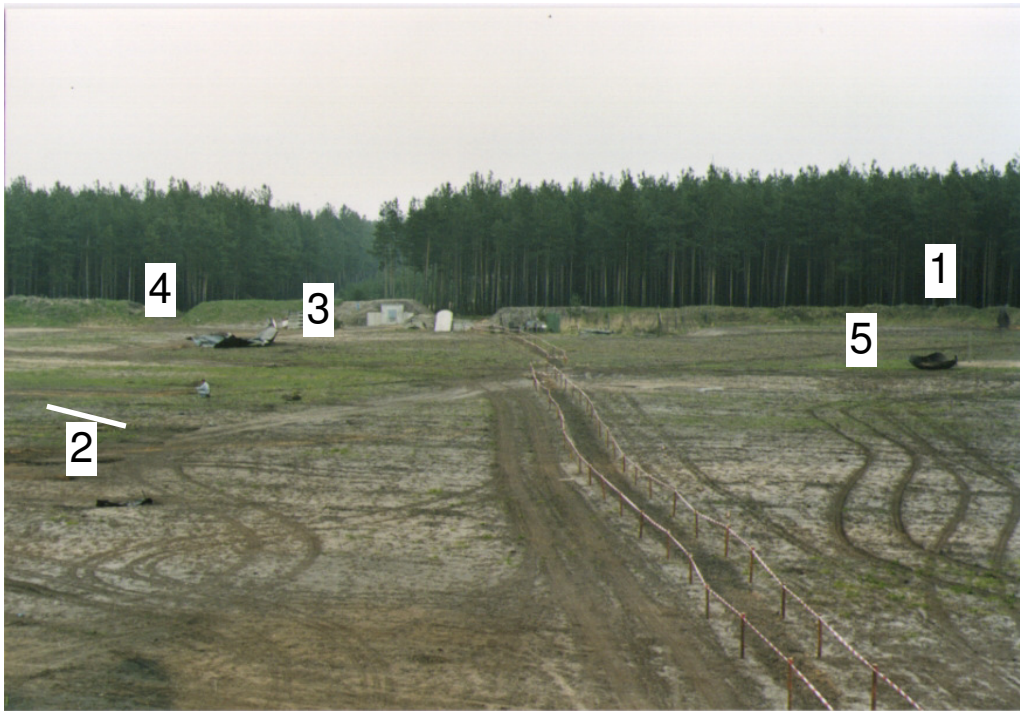

Fig. 19: Positions of the jacket sections and bottoms

Fig. 20 reveals the form of the jacket section. However, the follow-up examination revealed, that at this point in time the jacket was wrapped around its vertical axis.

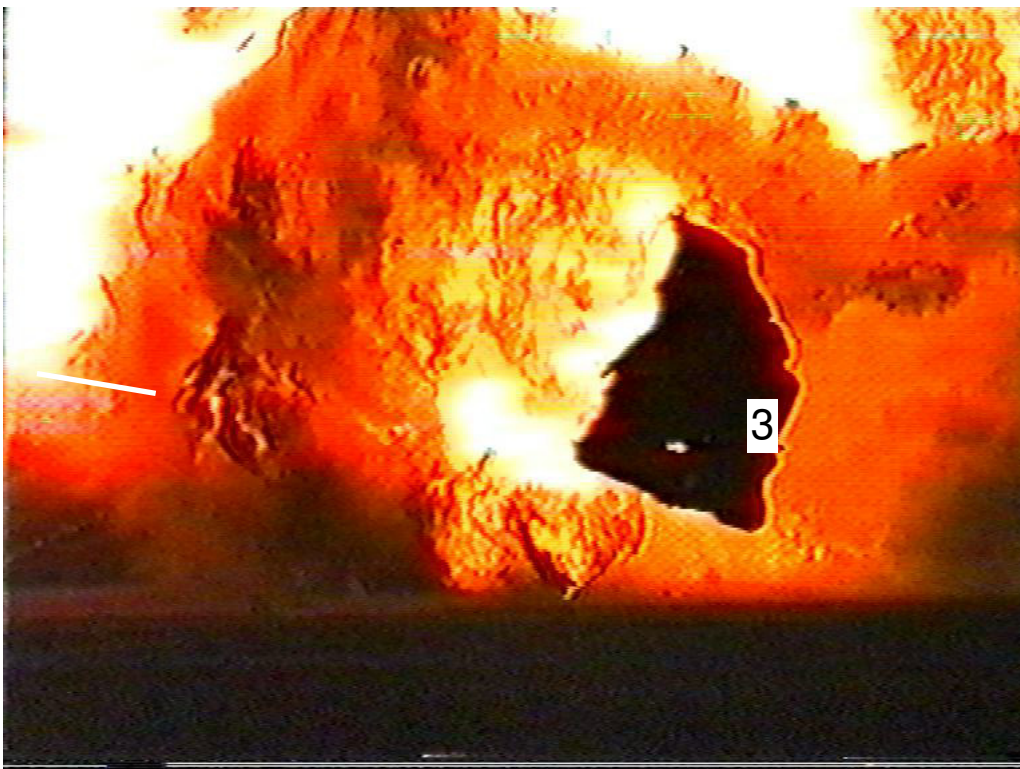

Fig. 20: Remaining part of the tank jacket

The exact place of bursting was found to be along a surface line running almost horizontally approx. 1.45 m above the rear mounting strip. The rupture started approx. 0.5 m to the left of the middle of the tank. In Fig. 20 this rupture line can be seen at the top and the bottom.

The following drawing shows the geometric arrangements of the tank car and the Castor in the fire troughs as well as the angles derived by measuring the arc lengths.

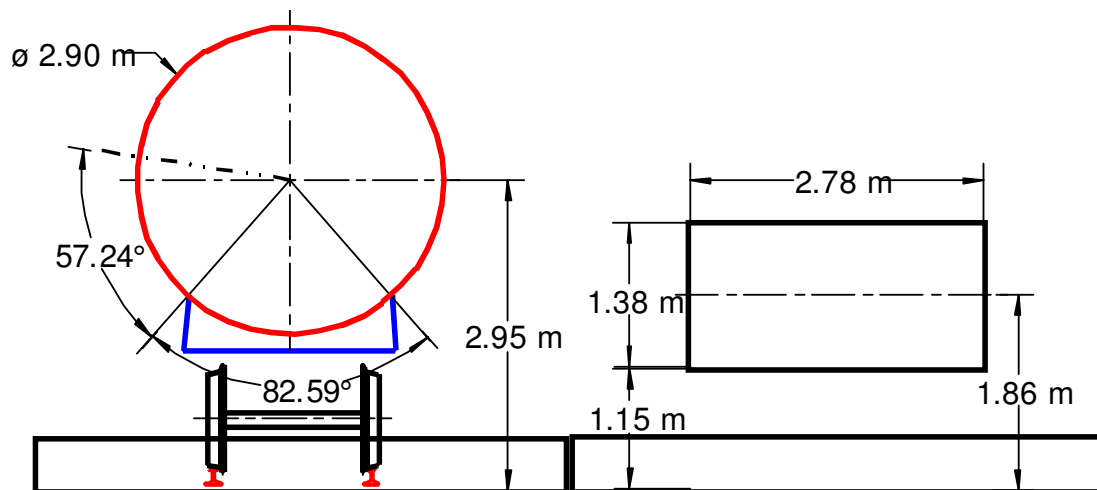

Fig. 21: Arrangement of the tank car and the Castor and the position of the rupture line

From this representation it can be seen that the rupture line was a little above the horizontal centre line. During the further course of the explosion, the tank folded apart both upwards and downwards.

The release of propane caused both the fuel tank and the chassis to be accelerated forwards. After the test, the chassis was found wrapped around the rack of the Castor, which had been shifted approx. 0.5 m by the impact.

Various smaller pieces of debris (e.g. the distribution cable, label plates) were found approx. 60 m away.

While the fuel oil in the Castor's fire trough continued to burn, the fire trough of the tank car was almost completely empty due to the effect of the explosion. The concrete slabs that had been placed around the fire troughs for stabilization had also been pushed outwards.

The buildings in the immediate vicinity of the test explosion as well as the measuring devices and the video equipment including cables all remained intact.



Fig. 22: Test stand immediately following the test

Only a smaller secondary fire, due apparently to flying sparks caused by the burning information signpost on the right next to the test site, had to be put out by the fire department.



Fig. 23: Test site seen from the right after the test

The Castor container was found tilted at an angle of approx. 20° with the cover downwards and approx. 7 m away (Fig. 24), after it had already moved 3.1 m from its original mid-point and had impacted the concrete elements with its bottom edge (see Fig. 25).



Fig. 24: Position of the Castor container after the test



Fig. 25: Traces of concrete on the bottom edge of the Castor

After the Castor had been uncovered, it was possible to examine its points of contact. The horizontal imprint of the tank car's mounting strip can be clearly seen.



Fig. 26: Traces of the tank car on the Castor container

Corresponding traces were also found on the jacket of the tank car. Figure 28 also shows the opening in the jacket already seen in Figure 20; this opening was apparently caused by contact with the Castor's support.



Fig 27: Dent in tank car's jacket, the point at which it came into contact with the Castor



Fig. 28: Opening in the jacket due to contact with Castor's support

6. Test results

Figure 29 shows the fire temperatures during the entire test.

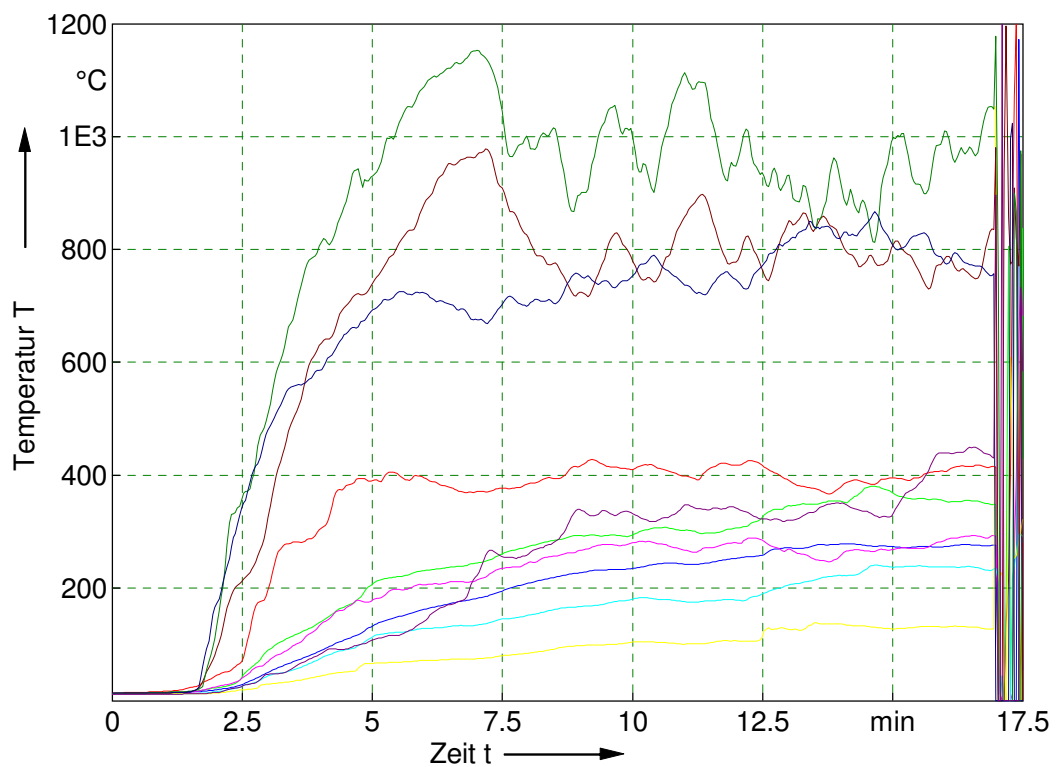

Fig. 29: Fire temperatures

The three upper curves are the temperatures at measurement points 201 (rear centre) 200 (rear left) and 202 (rear right). All other temperatures lie below 400 °C, which confirms the impression gained from the video recordings, that the tank was definitely not ideally enclosed by the fire.

It is also worth mentioning the relatively rapid increase at measurement point 114 (front left), which can be traced back to the effect of the Castor fire. However the maximum is clearly lower than in the rear area.

The fire temperature in the area of the fittings (measurement point 203, centre bottom) is also relatively low; only after approx. 16 minutes of firing did the temperature exceed 400°. The lowest curve is that of fire temperature 114 (vertex right), which did not exceed 135 °C. On the one hand, the reason for the temperature distribution of the fire could have been the prevailing wind conditions, and on the other hand it could also have been the rear embankment tunnel, which had been provided to install the relief line; this tunnel may have contributed to a better air supply than in the frontward area.

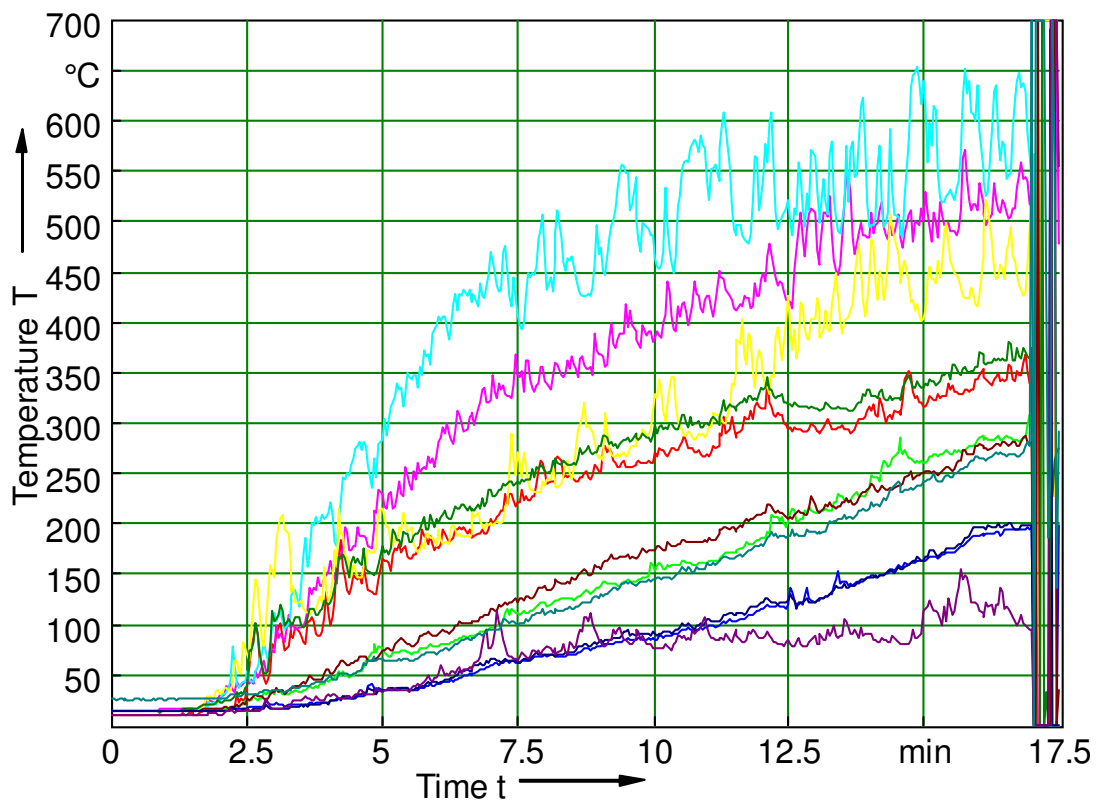

Fig. 30: Wall temperatures

The highest wall temperatures were found - corresponding to the fire temperatures - at measurement points 108 (rear centre), 107 (rear left) and 109 (rear right). At the time of rupture, their mean value was 550° C. This is followed by measurement point 111 (rear left, corresponding to fire temperature 200) with approx. 380 °C as well as measurement point

104 (front left) with approx. 360 °C. The lowest fire temperature was found at measurement point 113 (bottom centre, in the area of the fittings).

Because altogether there were only 11 temperature measuring points on the container wall, it was not possible to be sure to record the point having the highest temperature. However, it can be assumed that, because of the good agreement between the fire temperature and the wall temperature, the area in the proximity of the tank equator must have been the area with the highest temperature, and that the temperature at this point certainly could not have been lower than the highest measured temperatures.

The data available for the hot yield point of tank material BH 42K show the typical drop in the yield point of 420 N/mm² at 20 °C to 210 N/mm² at 400 °C. However the temperatures measured are at least half as high again so that, if the curve is projected linearly to measurement point 600 °C, a value of approx. 150 N/mm² is obtained for the hot yield point.

Due to the higher heat capacity, heat from the tank wall was transferred mainly to the liquid phase. The following diagram shows the temperatures of the liquid phase.

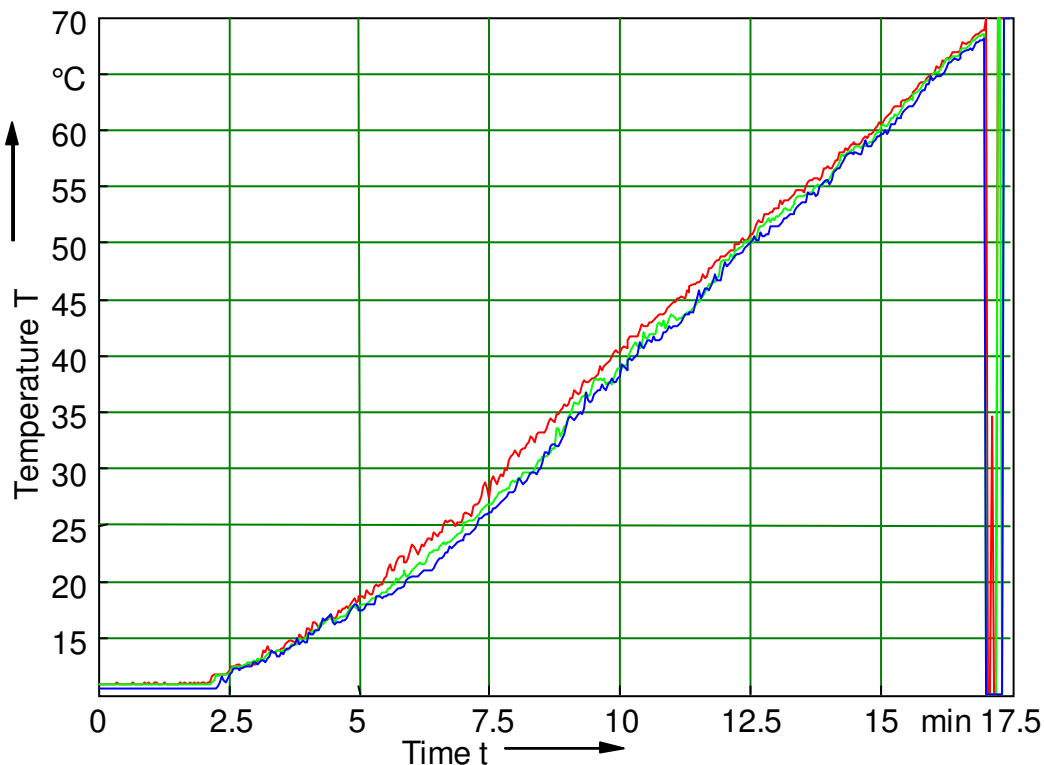

Fig. 31: Temperatures in the liquid phase

In contrast to the otherwise almost identical values at the single measurement points, in the zones between 5 and 12 minutes there are differences that point towards stratification. The mean temperature rise was approx. 4.48 K/min. The last highest temperature of the liquid state was determined as 68.8 °C.

The temperature of the liquid state is decisive for the pressure inside the tank. As the temperature increases, more propane evaporates; the resulting larger distances between the molecules causes an increase in pressure (see Figure 32). The mean rate of pressure increase was approx. 1.33 bar/min.

The maximum internal pressure recorded was 25.0 bar.

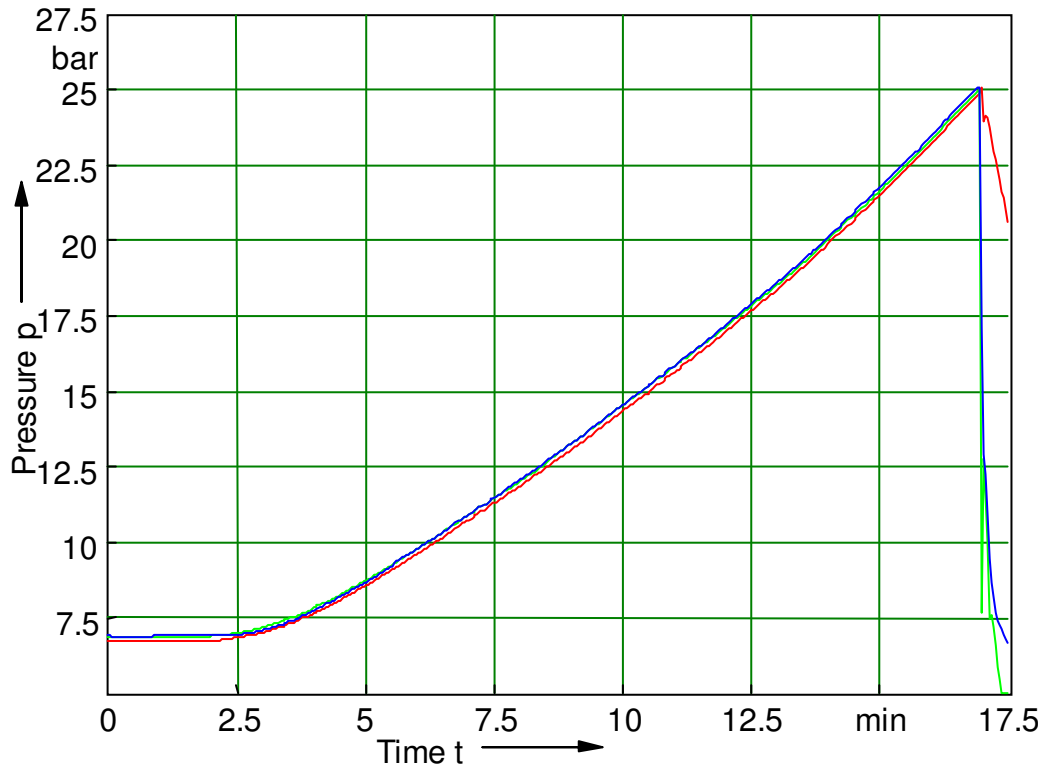

Fig. 32: Internal pressure of the tank during the course of the fire

Fig. 33 shows the change in internal pressure as a function of the temperature of the liquid state.

A comparison with the ideal vapour-pressure curve for propane shows good agreements for the initial and final values. The deviations in the area of middle temperatures can be explained with the fact that the temperature distribution within the liquid phase cannot be considered as uniform.

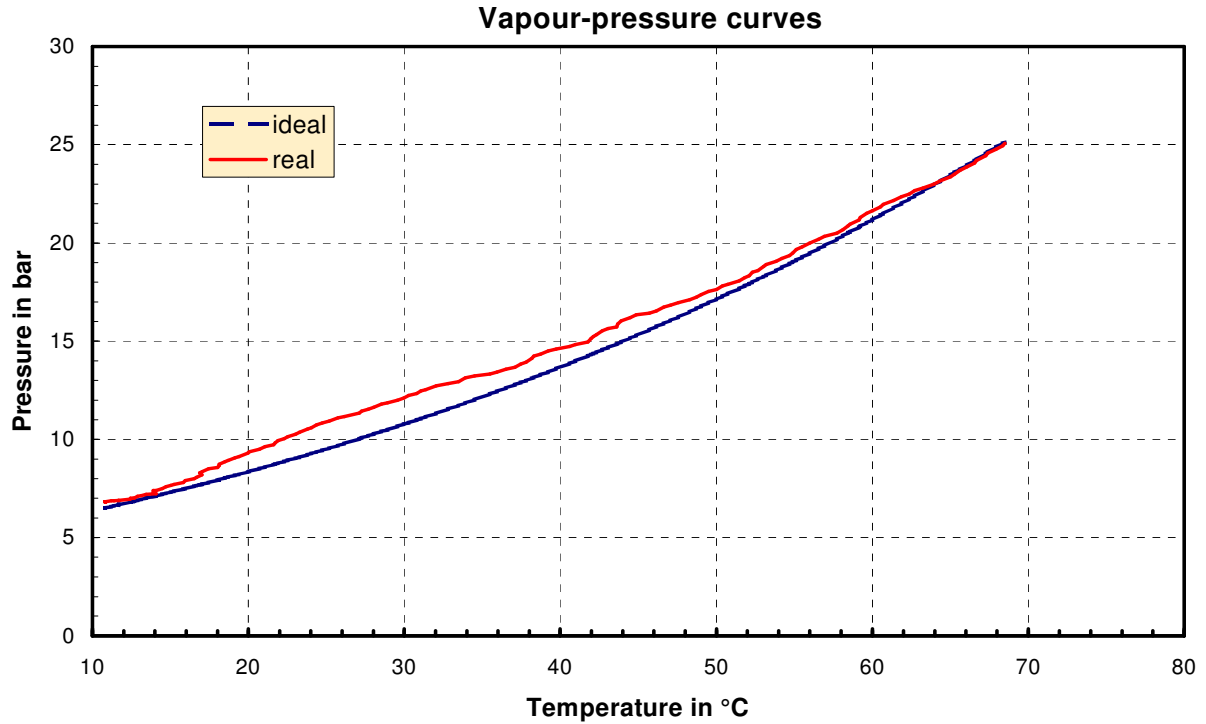

Fig. 33: Internal pressure of the tank as a function of the temperature of the liquid phase
 The fire temperatures measured around the Castor container are shown in Figure 34. Figure 35 shows the temperatures at the cover gaskets.

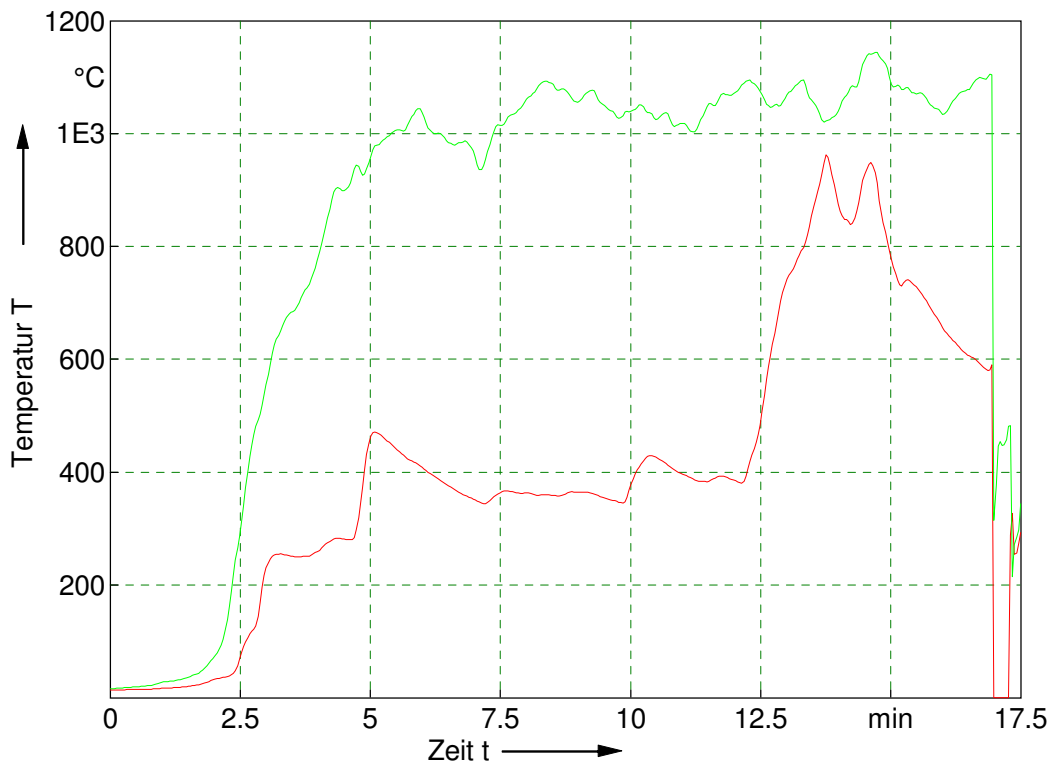

Fig. 34: Fire temperatures in the cover area of the Castor container

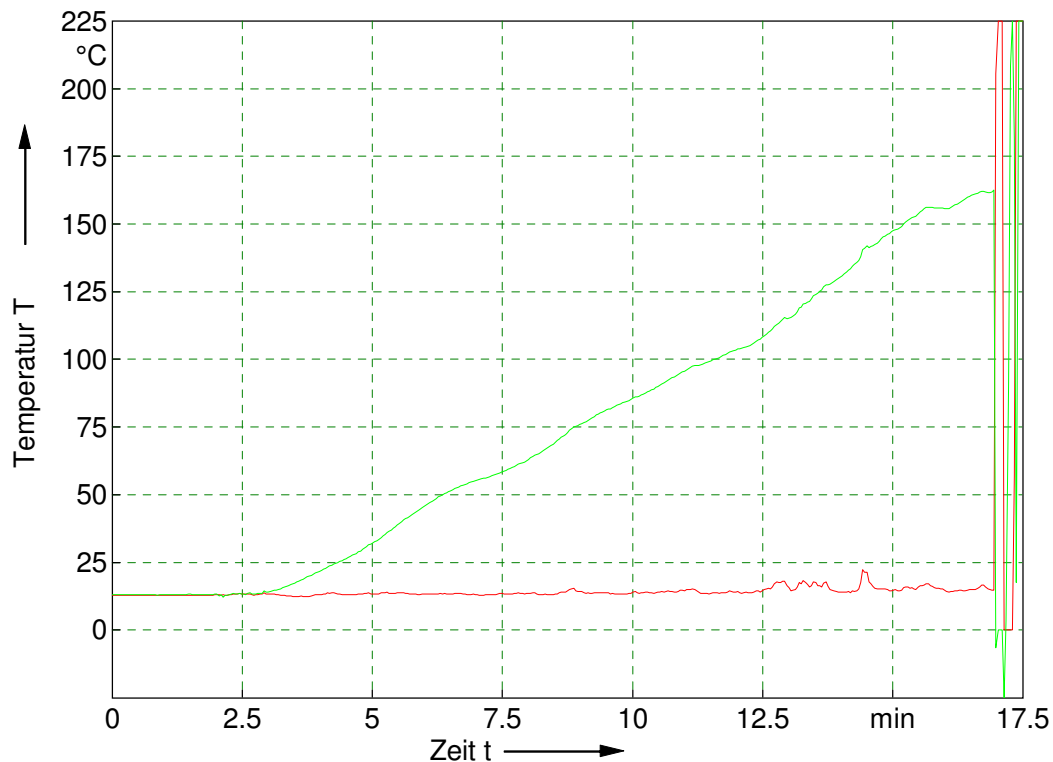

Fig. 35: Temperatures in the area of the primary and secondary cover gasket of the Castor

The various fire temperatures recorded around the Castor confirm the different fire envelopments experienced by the test objects due to the prevailing wind conditions. The upper curve shows the temperature at the left side of the cover. It was just towards the end of the test that the fire temperature measured also increased on the right side of the Castor.

The temperatures at the cover gaskets (Fig. 35) show a largely linear course. Because of the relatively short duration of the test, the area around the primary cover only heated up minimally.

The propagation of pressure in the direction of the ambient-pressure recorders was severely impaired both by the screening effect of the jacket as well as the flying debris.

As the tank jacket began to open up from the rear area, the unravelling jacket weakened the blast wave resulting from this significantly, so that the maximum values recorded were considerably less than expected.

Furthermore, the measurements made to determine the ambient pressure were impaired by the flying debris, which hurtled past in very close proximity to the sensors.

The scale of the time axis in the following representation is not identical to that used in the previous time curves.

Fig. 37 shows the condensation of air resulting from the blast wave.

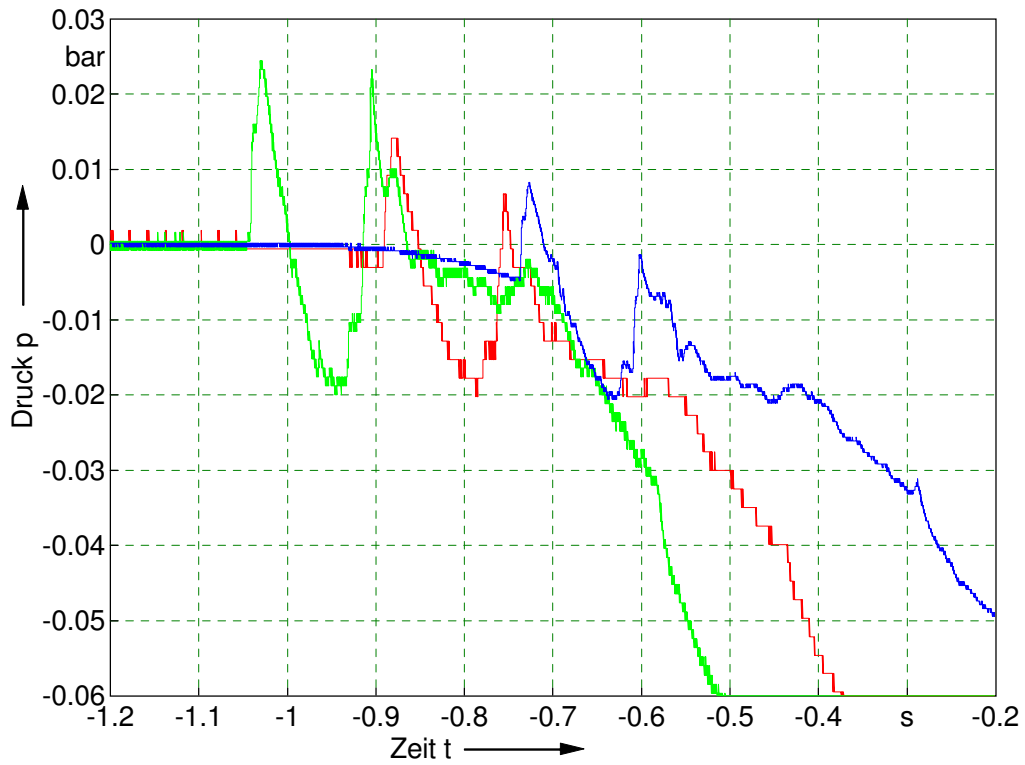

Fig. 36: Ambient pressures at 100 m, 150 m and 200 m from the test stand



Fig. 37: Condensation of air (approx. 200 ms after the rupture)

The time between the pressure maxima in Fig. 36 is 150 ms. Taking into account the speed of sound, the spatial distance between the measurement points calculates to 49.5 m. The question whether the steep decline of the curves during the course of the test was caused by flying debris or whether it was caused by the temperature dependence of the pressure sensors (thermoelectric effect) cannot be fully clarified.

Due to the failure of one recording device, only low-resolution data is available on heat radiation. No signal was recorded before the tank ruptured. This indicates that the sensors merely measured radiation from the fireball. Fig. 38 shows the relevant period of time. Due to the relatively low sampling rate available, it is only possible to state that the actual heat flow must have been greater than 80 kW/m^2 . Because it cannot be assumed that the fireball filled out the entire opening angle of the sensors, only a rough estimate can be derived from the measured data.

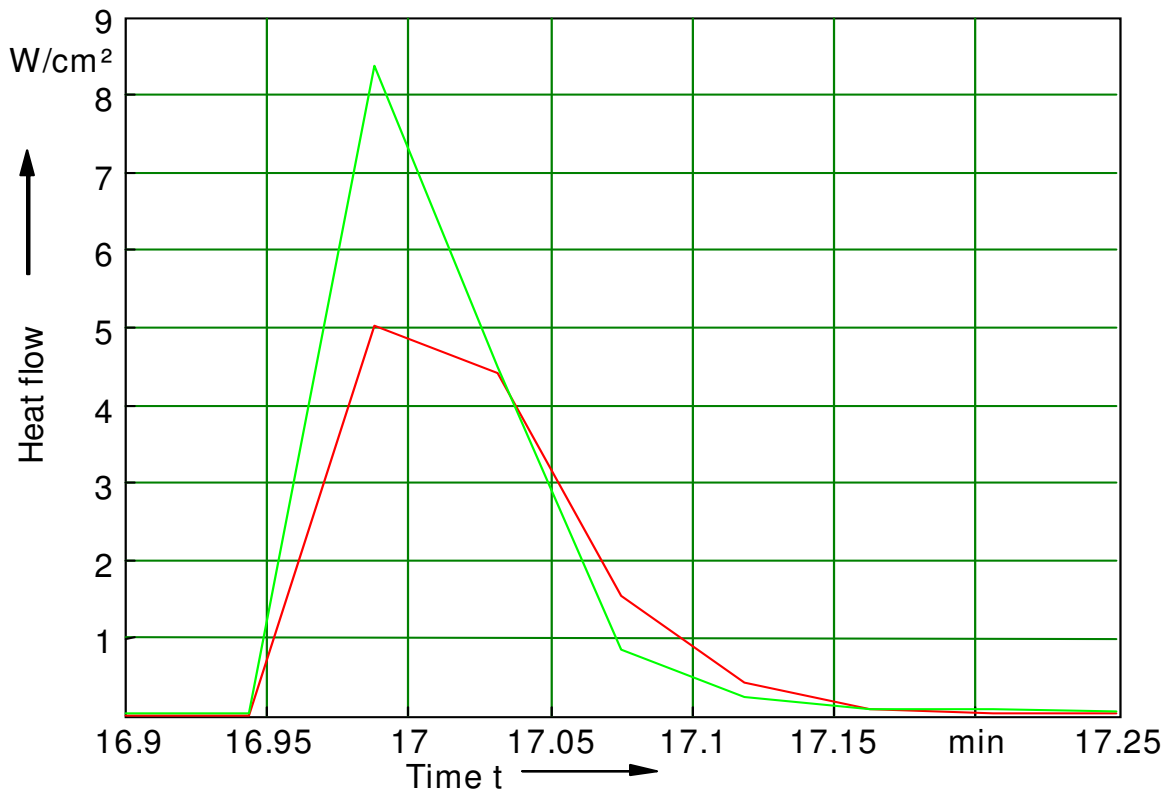

Fig. 38: Heat flow determined for the fireball

Except in two cases, the measurement ranges provided by the temperature strip charts were not adequate to determine the maximum temperature at the respective positions. The following table shows the values determined:

Direction	Distance from centre in m	Temperature in °C
front	30	> 254
front	50	< 116
left	30	< 143
left	50	> 188
rear	30	> 254
rear	50	> 188
right	30	> 254
right	50	> 188

However, it can be seen that the temperature distribution was not uniform. This can be explained by the fact that, because of the effects of the protective embankment and the wind conditions, there were different burn-off rates within the vapour cloud.

Preparing an overall energy balance for the test is rendered difficult by the different ways in which the debris was spread around. The different distances travelled by the various debris pieces hardly make it possible to determine their respective starting speeds because some of them had multiple ground contact on their way (rolling, sliding, raising up earth). The energy consumed to deform the individual debris parts, particularly the chassis of the tank car, is difficult to assess.

Only from the distance that the Castor was thrown is it possible to determine the speed, which it must have had after completing its acceleration phase caused by impact from the tank jacket. However, it is not possible to determine the exact time until which acceleration took place.

Even the video recordings do not provide more details about the impact process between the tank car and the Castor, because the evaporating or burning propane hid the entire area of interest.

7. Appendix

Measurement of wall thicknesses

Place	Values in mm						Mean value in mm
right bottom	16,66	16,61	16,63	16,66	16,68	16,01	16,54
left bottom	17,48	17,41	17,68	17,53	17,46	17,64	17,53
bottom overall							17,04
cylinder left	15,21	15,19	15,14	14,90	14,94	15,21	15,10
cylinder right	15,21	14,72	14,76	14,76	14,61	14,63	14,78
cylinder overall							14,94

The following diagrams show the temperature distribution during the test, based on the measured temperature-time characteristics found at the tank car.

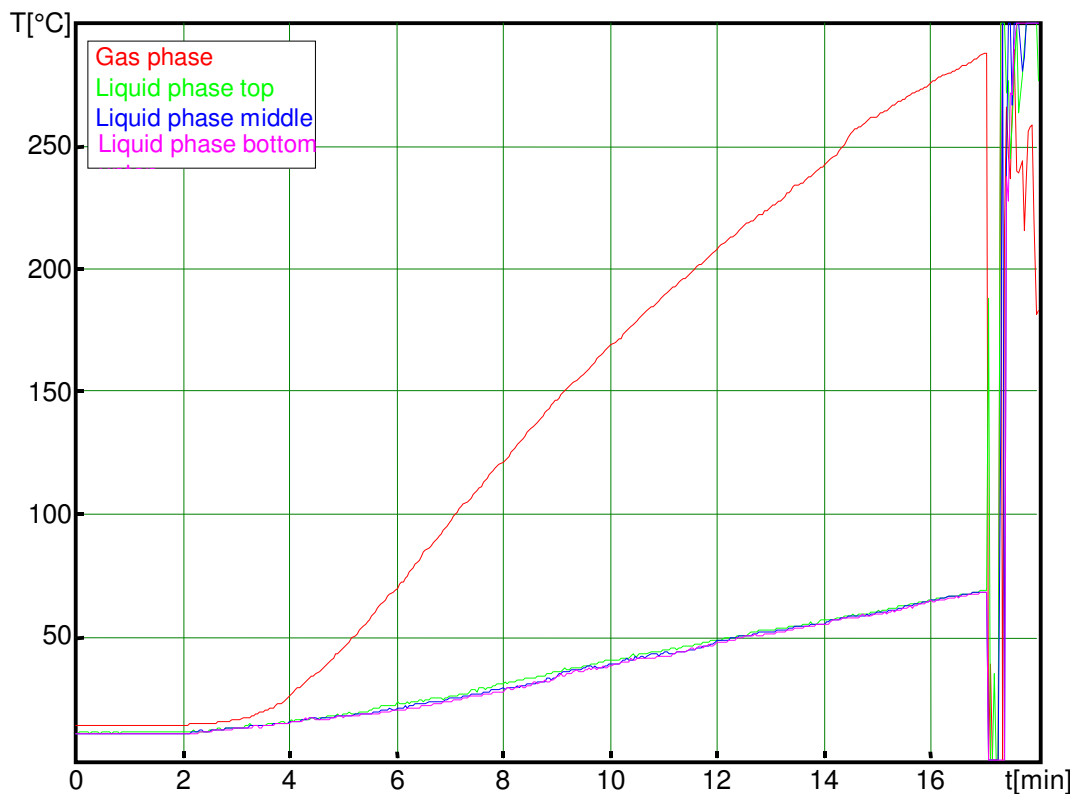

Time characteristic of the inner temperatures (gas and liquid phase)

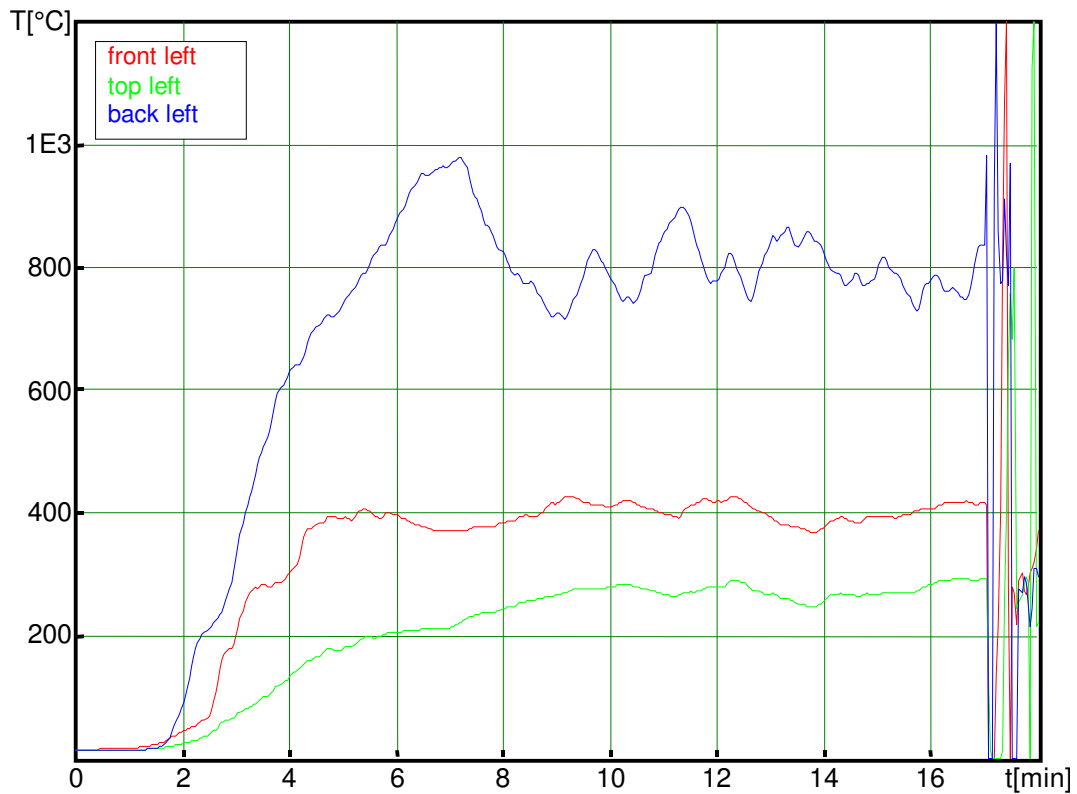

Time characteristic of the fire temperatures in the left plane

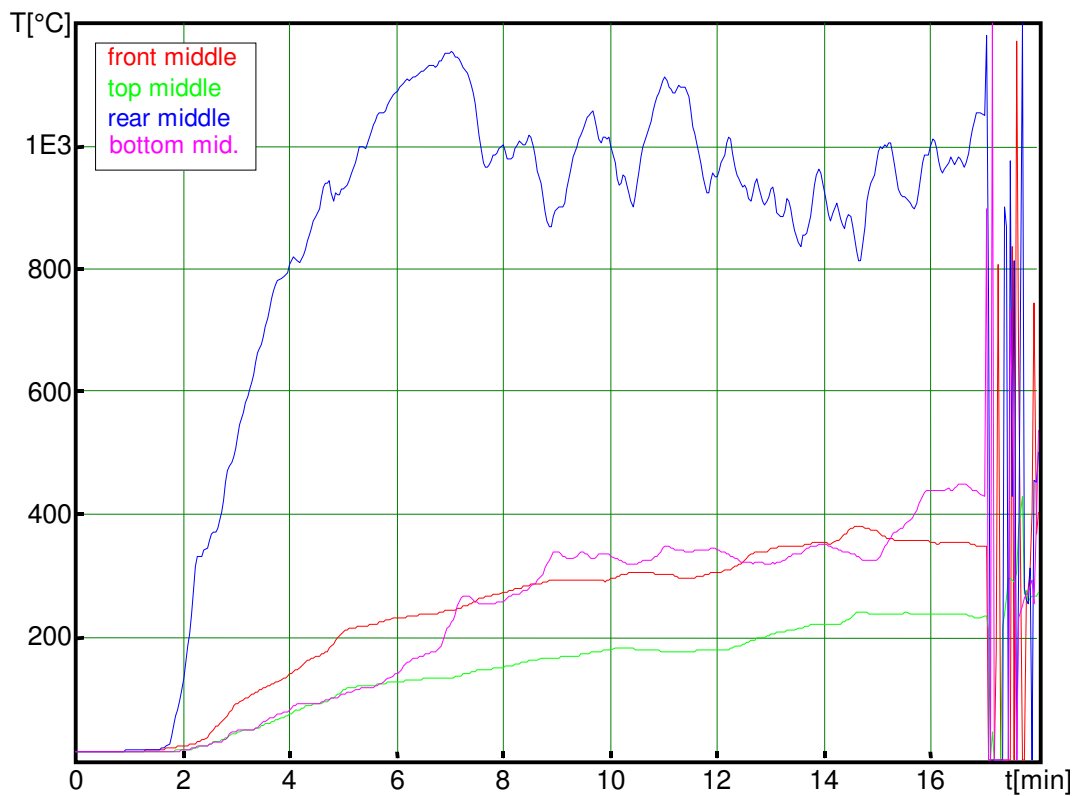

Time characteristic of the fire temperatures in the middle plane

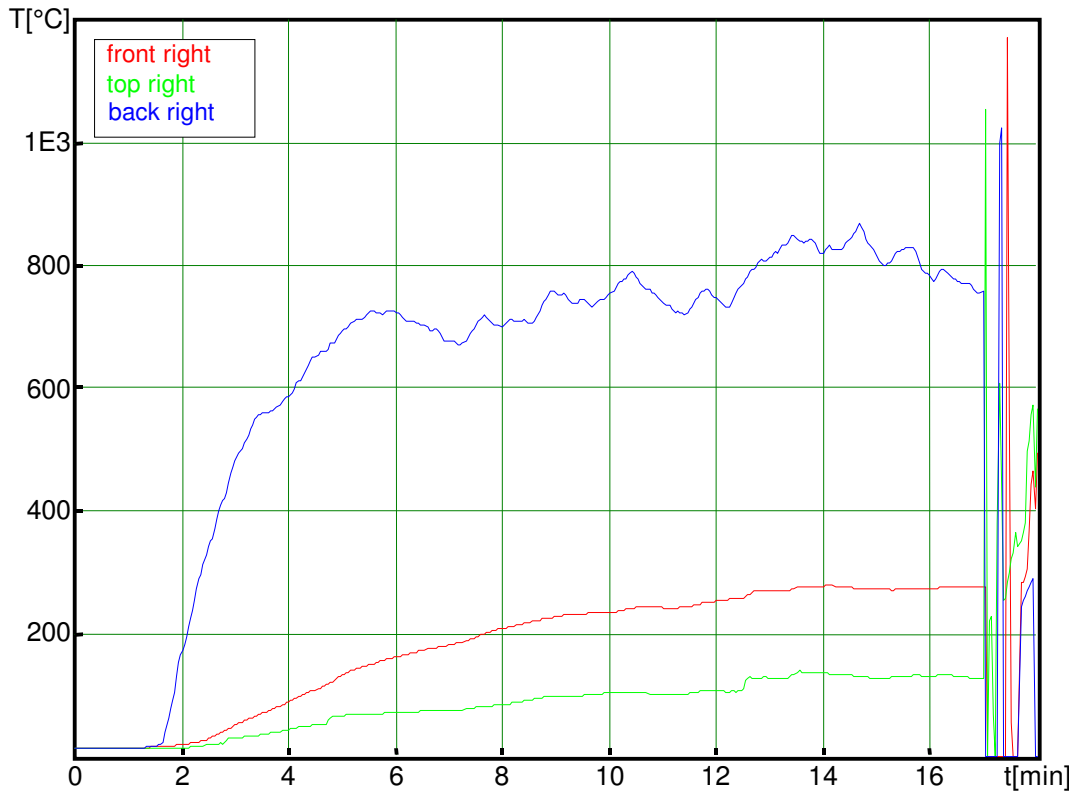

Time characteristic of the fire temperatures in the right plane

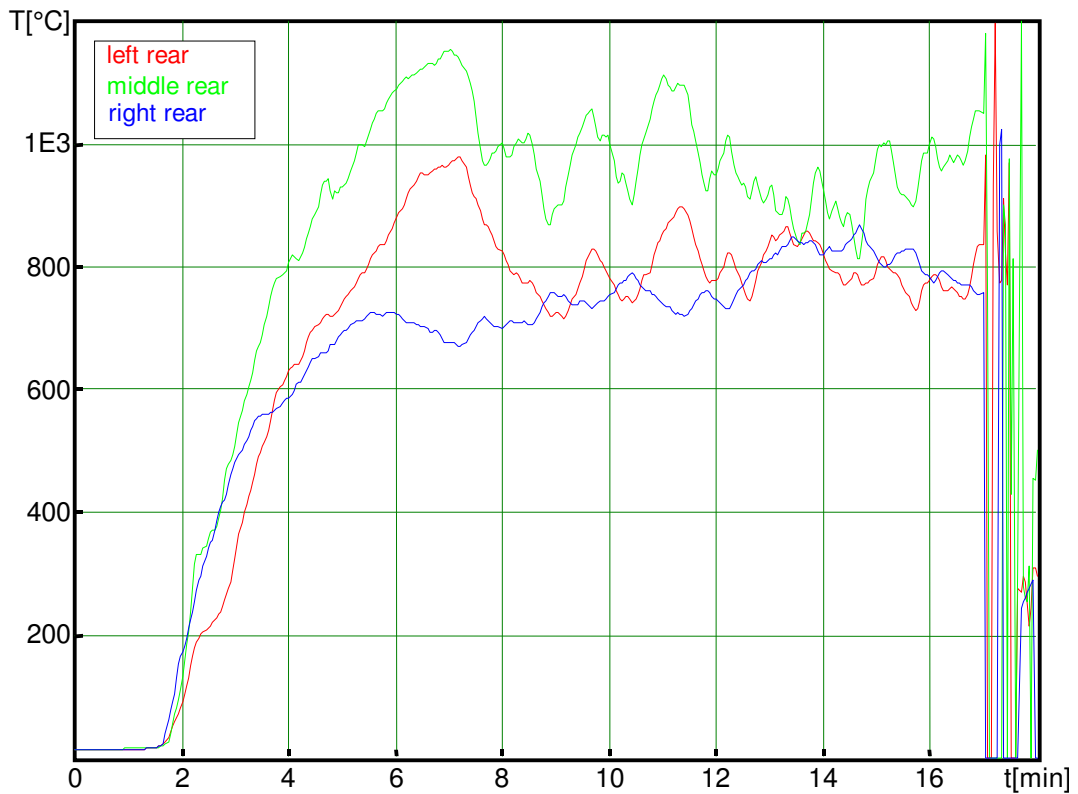

Time characteristic of the fire temperatures in the rear area

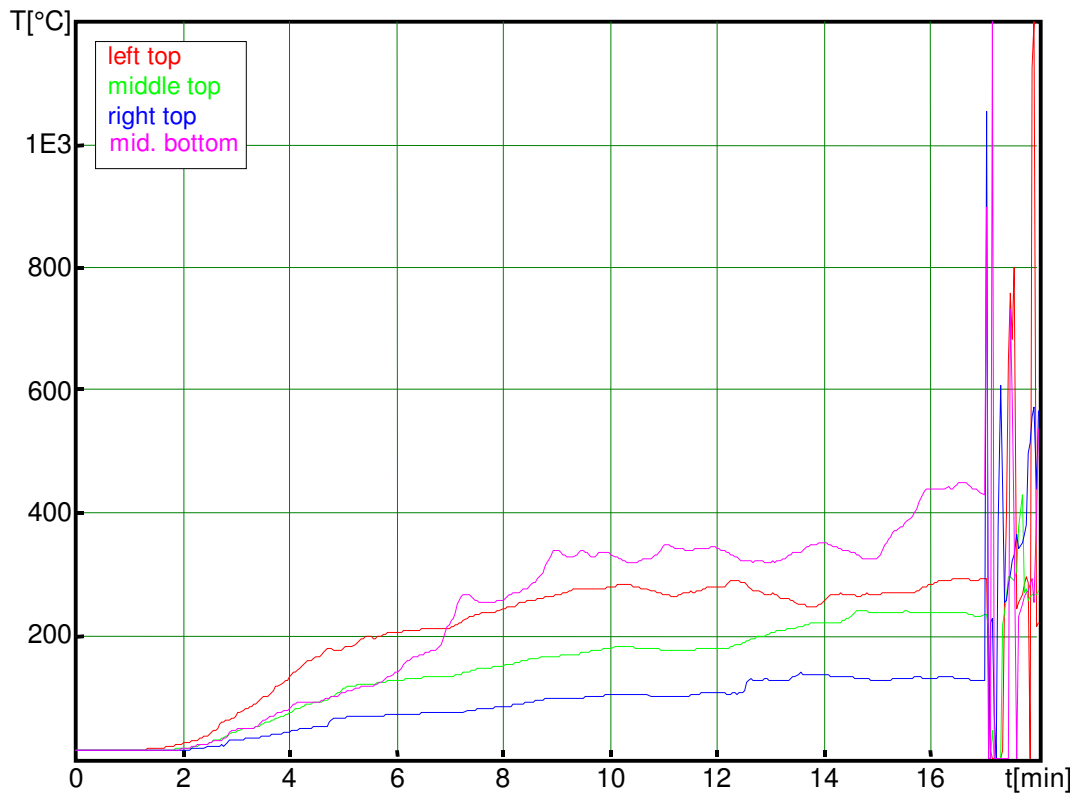

Time characteristic of the fire temperatures in the upper and lower area

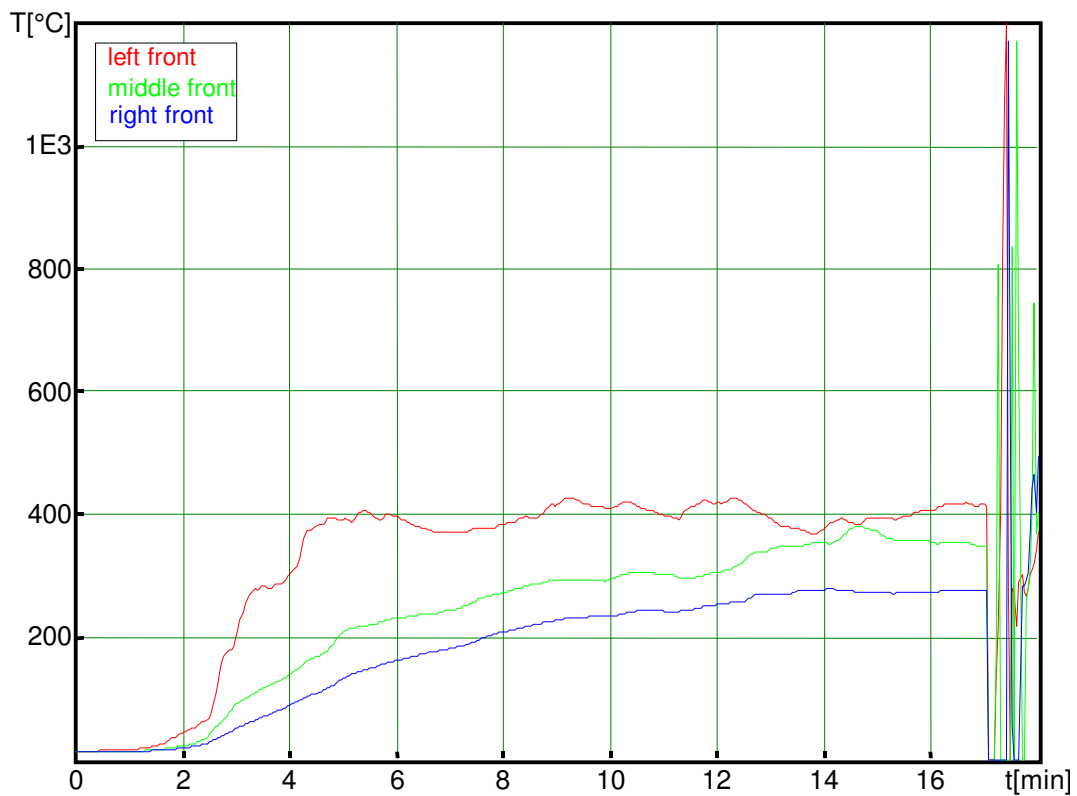

Time characteristic of the fire temperatures front area

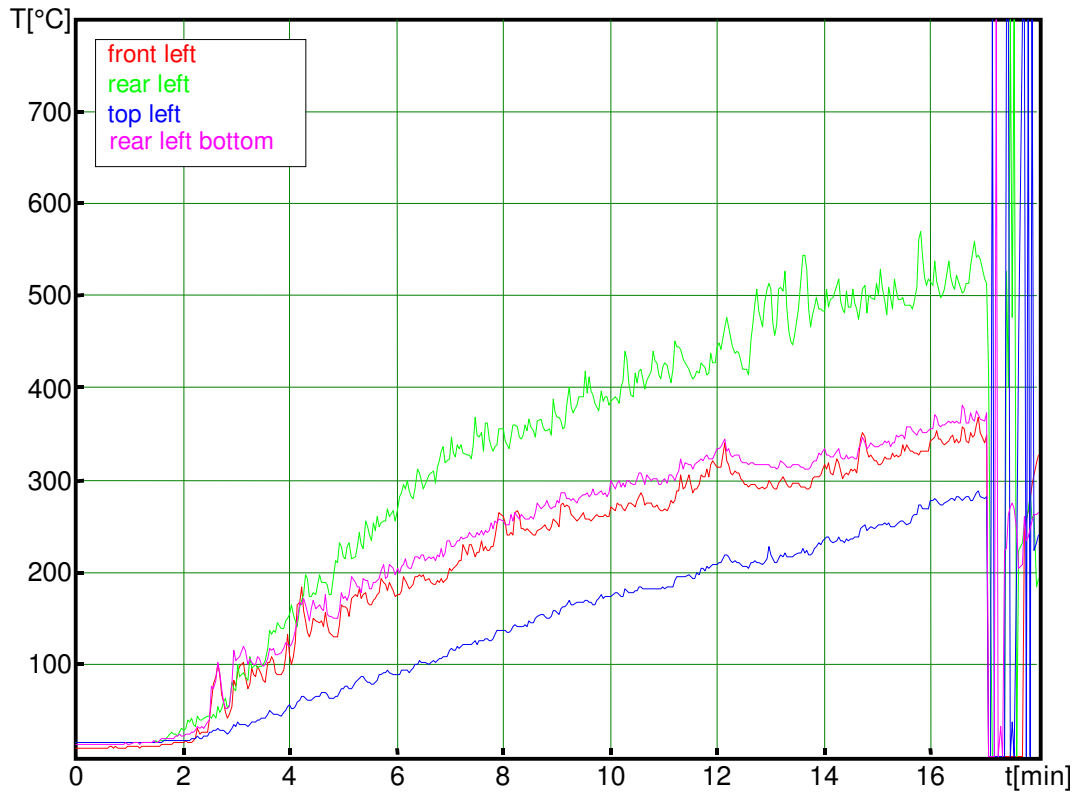

Time characteristic of the wall temperatures in the left plane

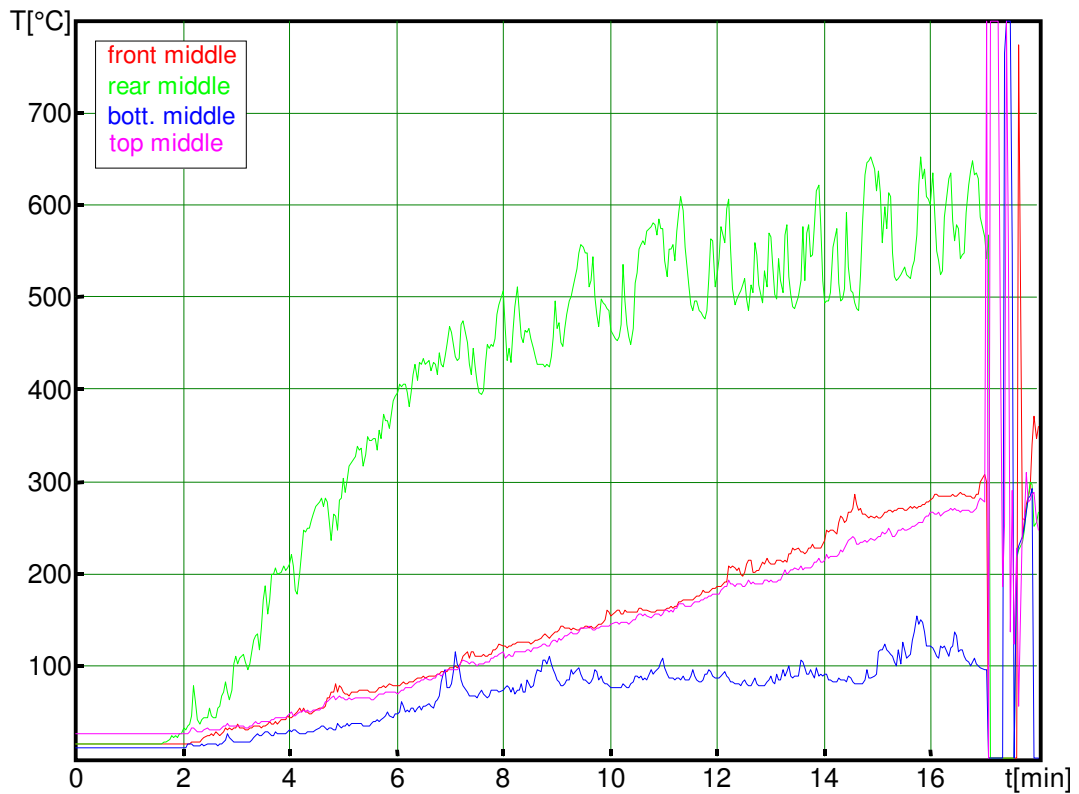

Time characteristic of the wall temperatures in the middle plane

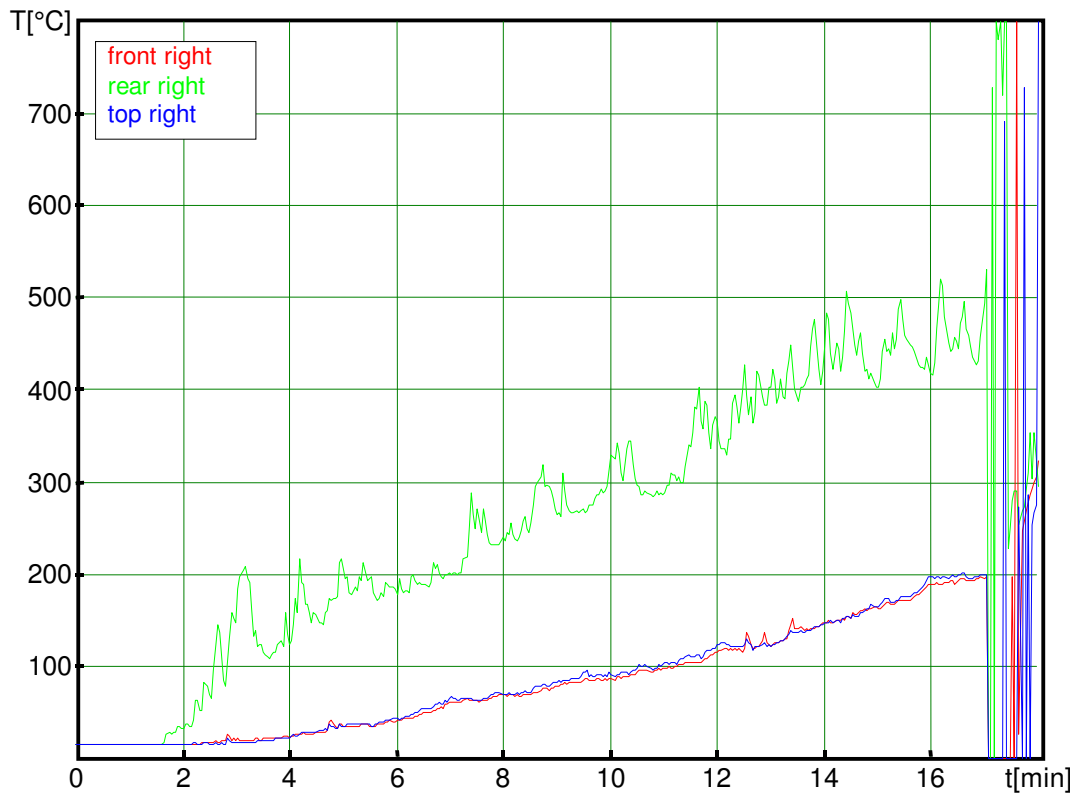

Time characteristic of the wall temperatures in the right plane

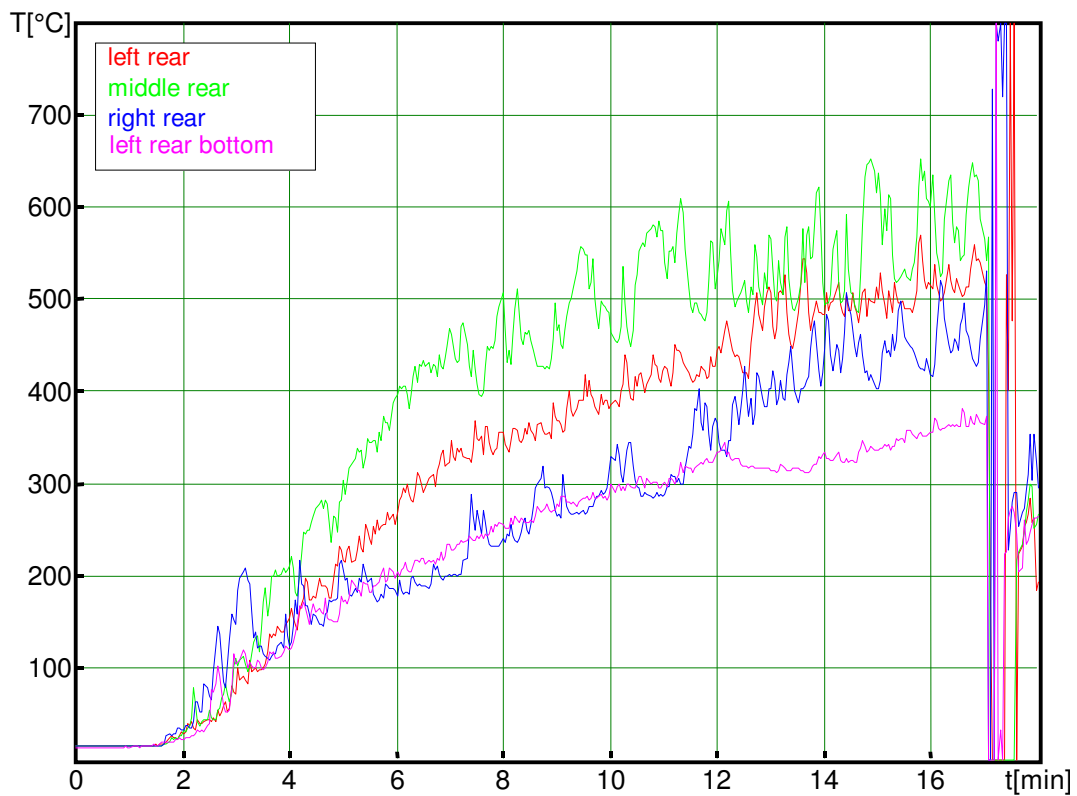

Time characteristic of the wall temperatures in the rear area

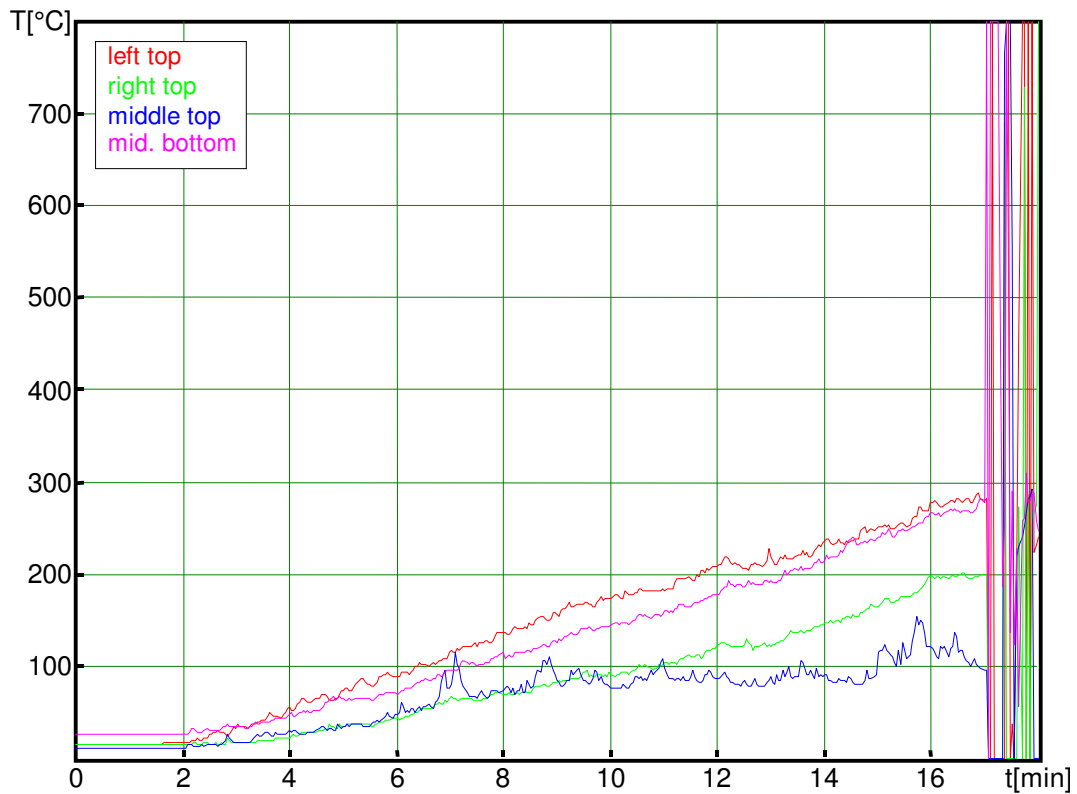

Time characteristic of the wall temperatures in the upper and lower area

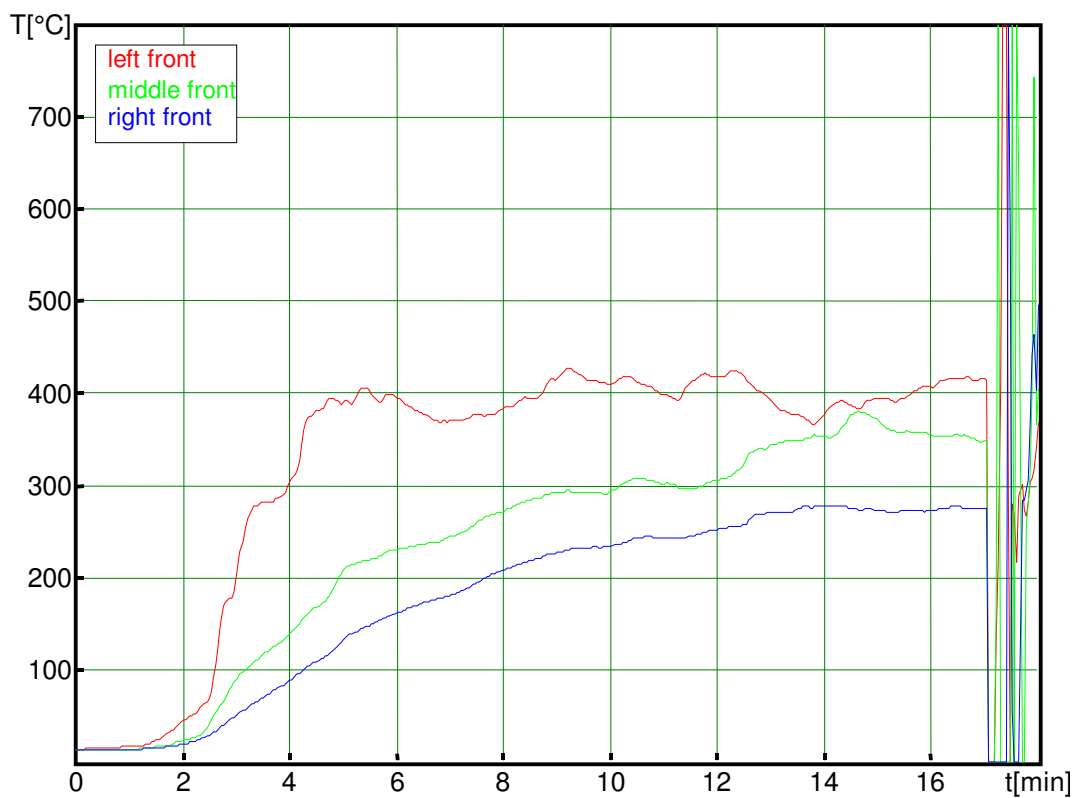

Time characteristic of the wall temperatures in the front area